



EBARA

6BHE

6" BOREHOLE PUMPS

50 Hz



6BHE 13 PERFORMANCE CURVES Pumps with Encapsulated Motor

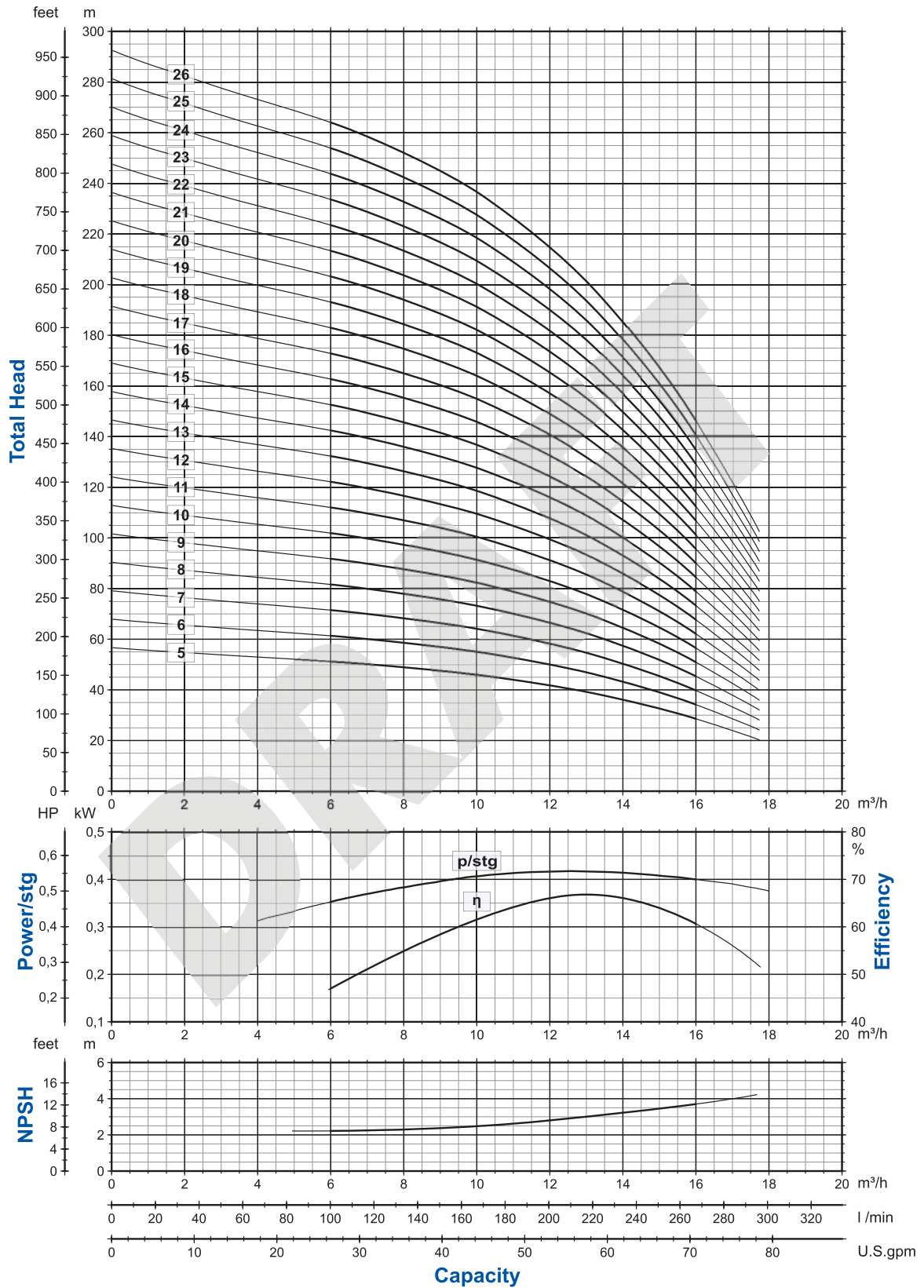

DIMENSIONAL TABLE

Model	Type	Motor kW	HP	Dimensions [mm]				D		Weight [kg]
				L1	L2	Lt		1 cable	2 cables	
6BHE 13/5	E4	2,2	3	413,5	422	835,5	142,5	-	26,5	
6BHE 13/6	E4	3,7	5	443,5	520	963,5	142,5	-	32	
6BHE 13/7	E4	3,7	5	473,5	520	993,5	142,5	-	32	
6BHE 13/8	E4	3,7	5	503,5	520	1023,5	142,5	-	33	
6BHE 13/9	E4	5,5	7,5	533,5	652,5	1186	142,5	-	41	
6BHE 13/10	E4	5,5	7,5	563,5	652,5	1216	142,5	-	41,5	
6BHE 13/11	E4	5,5	7,5	593,5	652,5	1246	142,5	-	42,5	
6BHE 13/12	E4	5,5	7,5	623,5	652,5	1276	142,5	-	43,5	
6BHE 13/13	E4	5,5	7,5	653,5	652,5	1306	142,5	-	44	
6BHE 13/14	E4	7,5	10	683,5	730,5	1414	142,5	-	49	
6BHE 13/15	E4	7,5	10	713,5	730,5	1444	142,5	-	49,5	
6BHE 13/16	E4	7,5	10	743,5	730,5	1474	142,5	-	50,5	
6BHE 13/17	E4	7,5	10	773,5	730,5	1504	142,5	-	51	
6BHE 13/5	E6	4	5,5	411	581	992	143	144,5	49	
6BHE 13/6	E6	4	5,5	441	581	1022	143	144,5	50	
6BHE 13/7	E6	4	5,5	471	581	1052	143	144,5	50,5	
6BHE 13/8	E6	4	5,5	501	581	1082	143	144,5	51,5	
6BHE 13/9	E6	5,5	7,5	531	614,5	1145,5	143	144,5	55,5	
6BHE 13/10	E6	5,5	7,5	561	614,5	1175,5	143	144,5	56	
6BHE 13/11	E6	5,5	7,5	591	614,5	1205,5	143	144,5	57	
6BHE 13/12	E6	5,5	7,5	621	614,5	1235,5	143	144,5	58	
6BHE 13/13	E6	5,5	7,5	651	614,5	1265,5	143	144,5	58,5	
6BHE 13/14	E6	7,5	10	681	646	1327	143	144,5	63,5	
6BHE 13/15	E6	7,5	10	711	646	1357	143	144,5	64	
6BHE 13/16	E6	7,5	10	741	646	1387	143	144,5	65	
6BHE 13/17	E6	7,5	10	771	646	1417	143	144,5	65,5	
6BHE 13/18	E6	9,3	12,5	801	678,5	1479,5	143	144,5	69	
6BHE 13/19	E6	9,3	12,5	831	678,5	1509,5	143	144,5	69,5	
6BHE 13/20	E6	9,3	12,5	861	678,5	1539,5	143	144,5	70,5	
6BHE 13/21	E6	9,3	12,5	891	678,5	1569,5	143	144,5	71	
6BHE 13/22	E6	9,3	12,5	921	678,5	1599,5	143	144,5	71,5	
6BHE 13/23	E6	11	15	951	711	1662	143	144,5	76	
6BHE 13/24	E6	11	15	981	711	1692	143	144,5	76,5	
6BHE 13/25	E6	11	15	1011	711	1722	143	144,5	77,5	
6BHE 13/26	E6	11	15	1041	711	1752	143	144,5	78	

DIMENSIONS

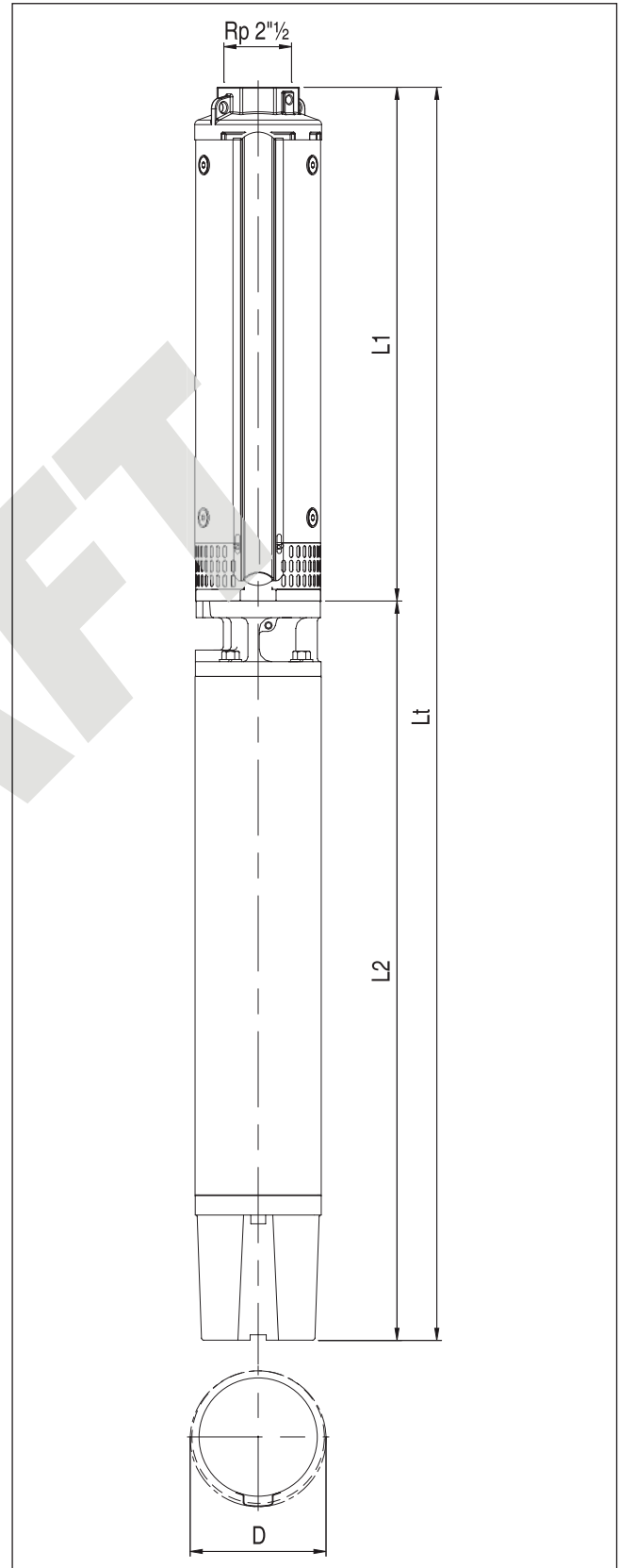

6BHE 13 PERFORMANCE CURVES Pumps with Encapsulated Motor

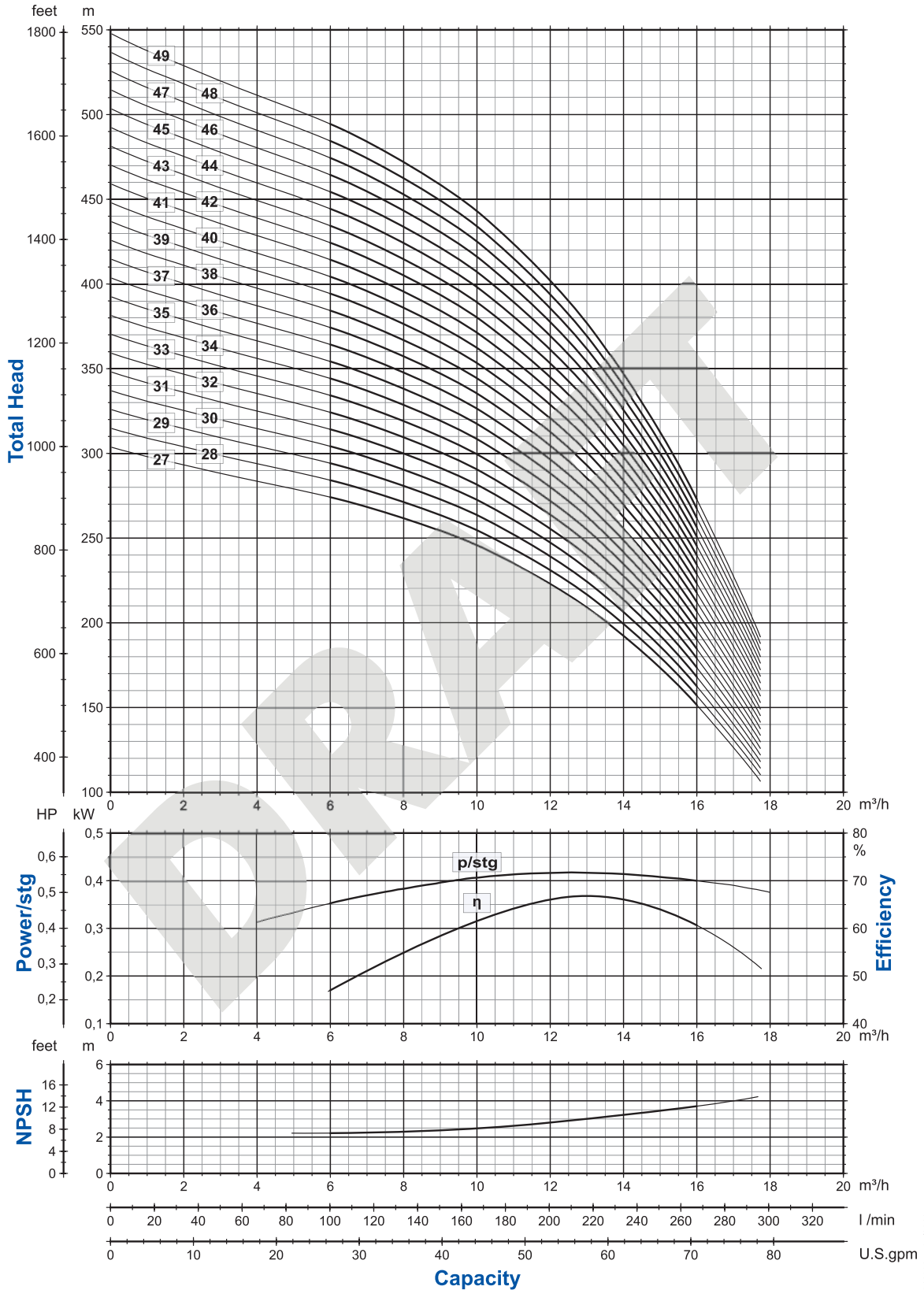

00110067 07/2010

DIMENSIONAL TABLE

Model	Type	Motor kW	HP	Dimensions [mm]					Weight [kg]
				L1	L2	Lt	D		
							1 cable	2 cables	
6BHE 13/27	E6	15	20	1071	776	1847	143	144,5	85,5
6BHE 13/28	E6	15	20	1101	776	1877	143	144,5	85,5
6BHE 13/29	E6	15	20	1131	776	1907	143	144,5	87
6BHE 13/30	E6	15	20	1161	776	1937	143	144,5	87,5
6BHE 13/31	E6	15	20	1191	776	1967	143	144,5	87,5
6BHE 13/32	E6	15	20	1220,5	776	1996,5	143	144,5	88
6BHE 13/33	E6	15	20	1250,5	776	2026,5	143	144,5	89
6BHE 13/34	E6	15	20	1280,5	776	2056,5	143	144,5	90
6BHE 13/35	E6	15	20	1310,5	776	2086,5	143	144,5	90,5
6BHE 13/36	E6	15	20	1340,5	776	2116,5	143	144,5	91
6BHE 13/37	E6	18,5	25	1370,5	841,5	2212	143	144,5	99
6BHE 13/38	E6	18,5	25	1400,5	841,5	2242	143	144,5	99,5
6BHE 13/39	E6	18,5	25	1430,5	841,5	2272	143	144,5	101
6BHE 13/40	E6	18,5	25	1460,5	841,5	2302	143	144,5	102
6BHE 13/41	E6	18,5	25	1490,5	841,5	2332	143	144,5	102,5
6BHE 13/42	E6	18,5	25	1520,5	841,5	2362	143	144,5	102,5
6BHE 13/43	E6	18,5	25	1550,5	841,5	2392	143	144,5	103,5
6BHE 13/44	E6	18,5	25	1580,5	841,5	2422	143	144,5	104
6BHE 13/45	E6	22	30	1610,5	906,5	2517	143	144,5	111
6BHE 13/46	E6	22	30	1640,5	906,5	2547	143	144,5	111,5
6BHE 13/47	E6	22	30	1670,5	906,5	2577	143	144,5	112,5
6BHE 13/48	E6	22	30	1700	906,5	2606,5	143	144,5	113,5
6BHE 13/49	E6	22	30	1730,5	906,5	2637	143	144,5	114,5

DIMENSIONS

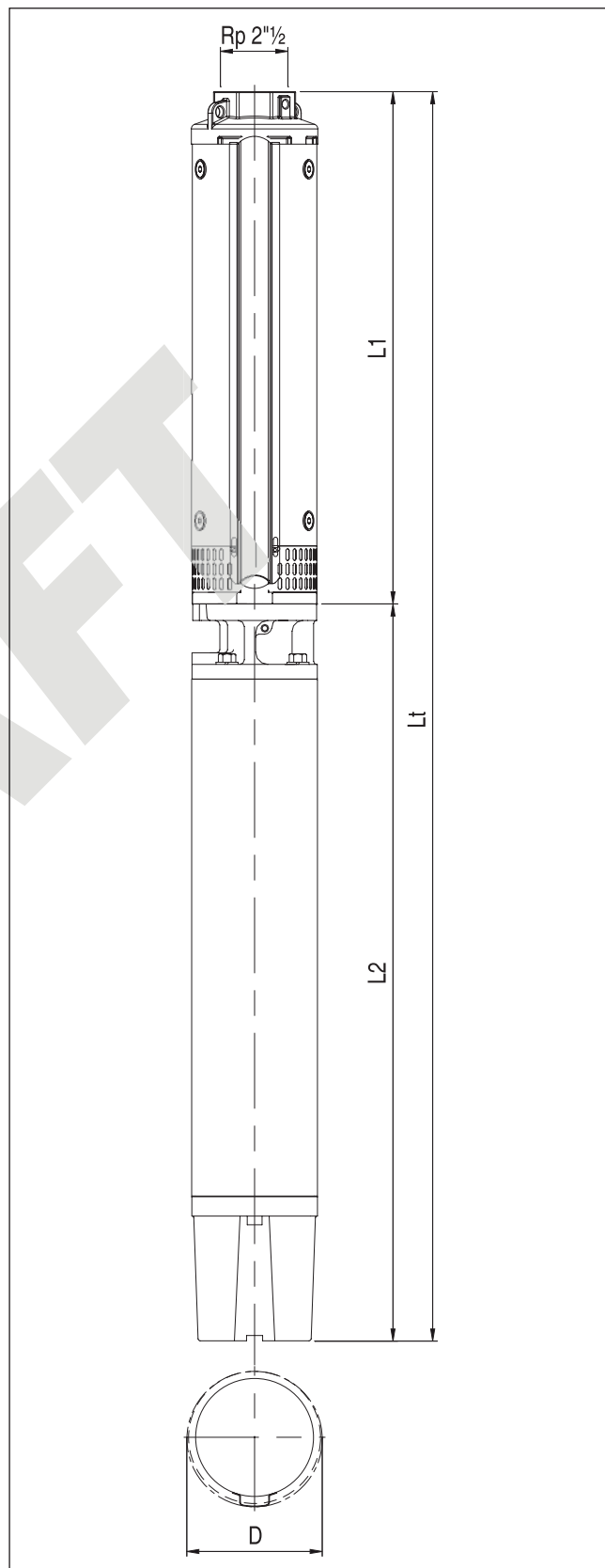

6BHE 13 PERFORMANCE CURVES Pumps with Encapsulated Motor

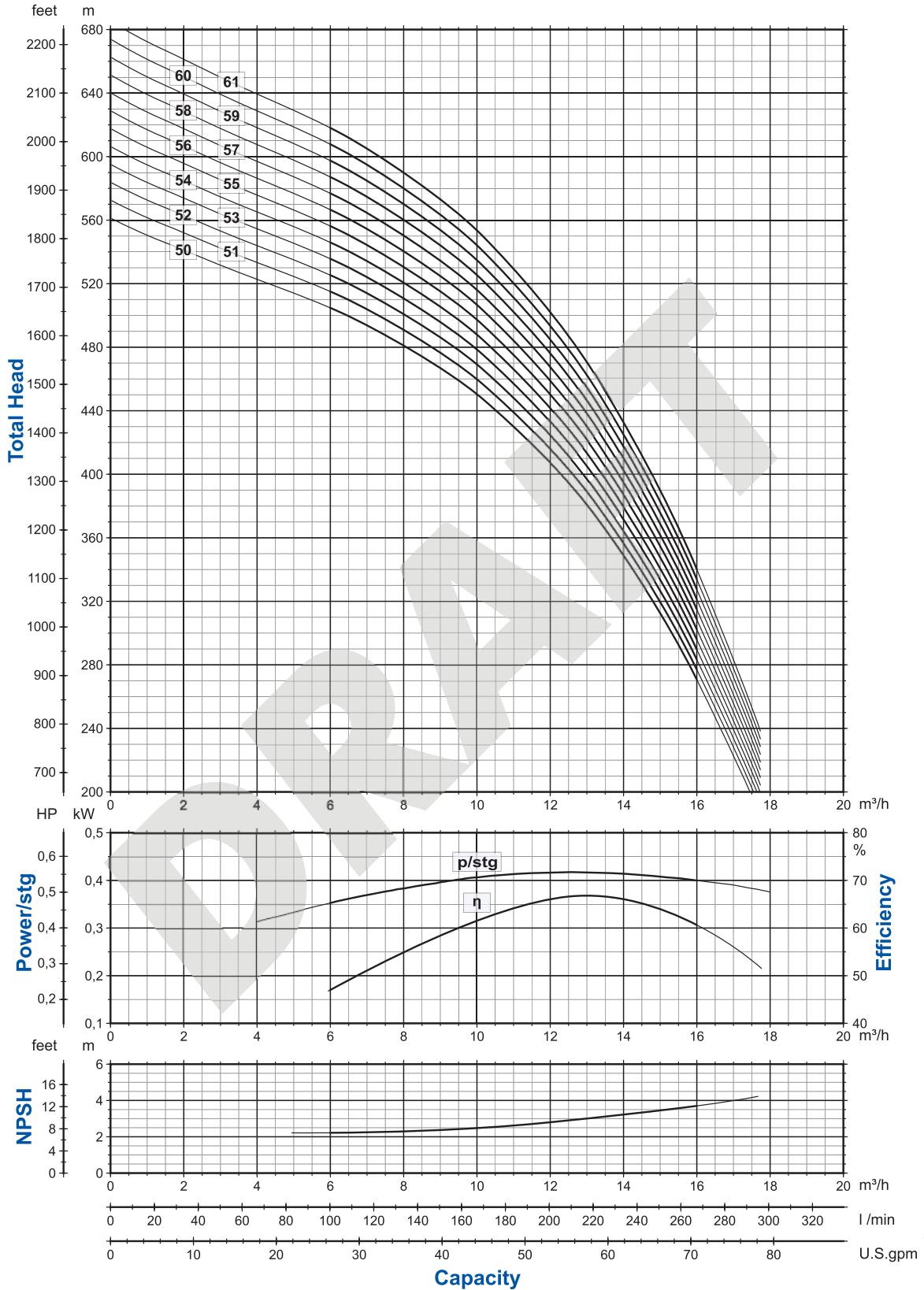

00110067_07/2010

DIMENSIONAL TABLE

Model	Type	Motor kW	HP	L1	Dimensions [mm]			D		Weight [kg]
					L2	Lt	1 cable	2 cables		
6BHE 13/50	E6	22	30	1760,5	906,5	2667	145	146,5	115,5	
6BHE 13/51	E6	22	30	1790,5	906,5	2697	145	146,5	116,5	
6BHE 13/52	E6	22	30	1820,5	906,5	2727	145	146,5	117,5	
6BHE 13/53	E6	30	40	1850,5	1036,5	2887	145	146,5	133	
6BHE 13/54	E6	30	40	1880,5	1036,5	2917	145	146,5	133,5	
6BHE 13/55	E6	30	40	1910,5	1036,5	2947	145	146,5	134,5	
6BHE 13/56	E6	30	40	1940,5	1036,5	2977	145	146,5	135,5	
6BHE 13/57	E6	30	40	1970,5	1036,5	3007	145	146,5	136	
6BHE 13/58	E6	30	40	2000	1036,5	3036,5	145	146,5	137	
6BHE 13/59	E6	30	40	2030	1036,5	3066,5	145	146,5	138	
6BHE 13/60	E6	30	40	2060	1036,5	3096,5	145	146,5	139	
6BHE 13/61	E6	30	40	2090	1036,5	3126,5	145	146,5	140	

DIMENSIONS

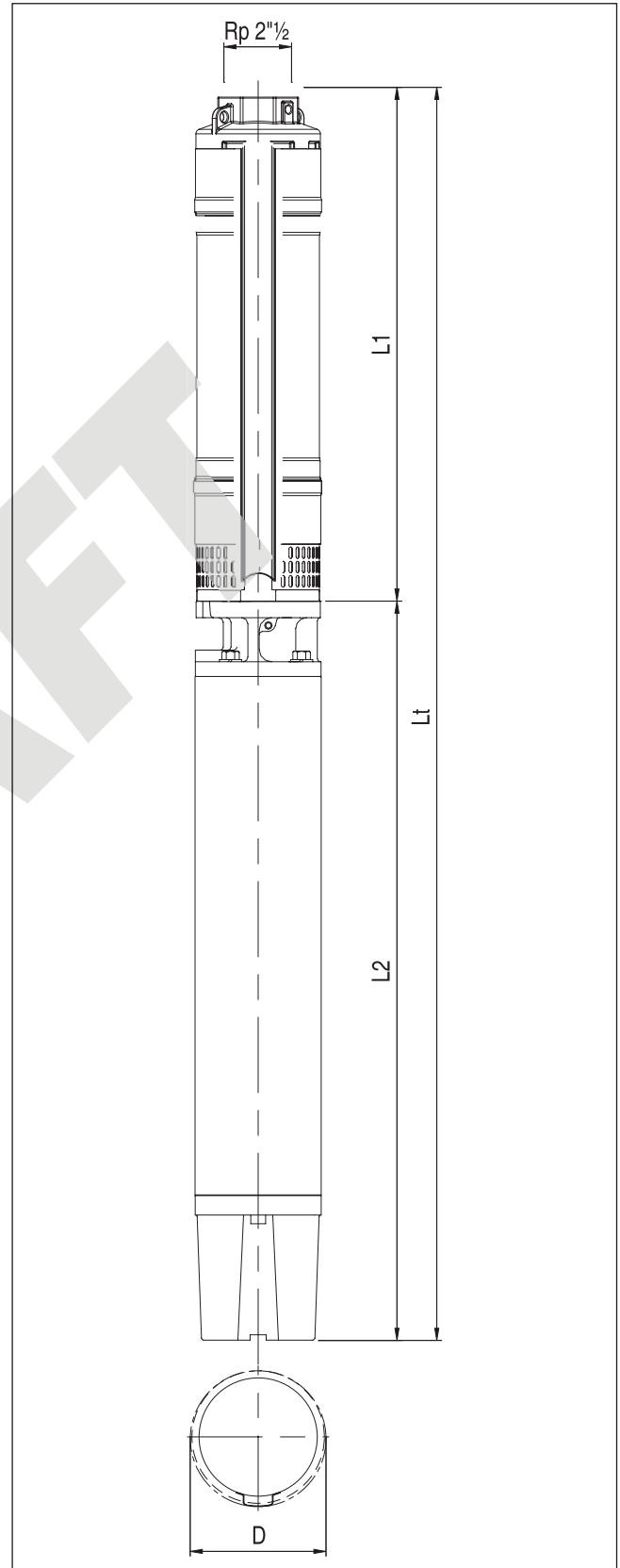



6BHE

6BHE 20 PERFORMANCE CURVES Pumps with Encapsulated Motor

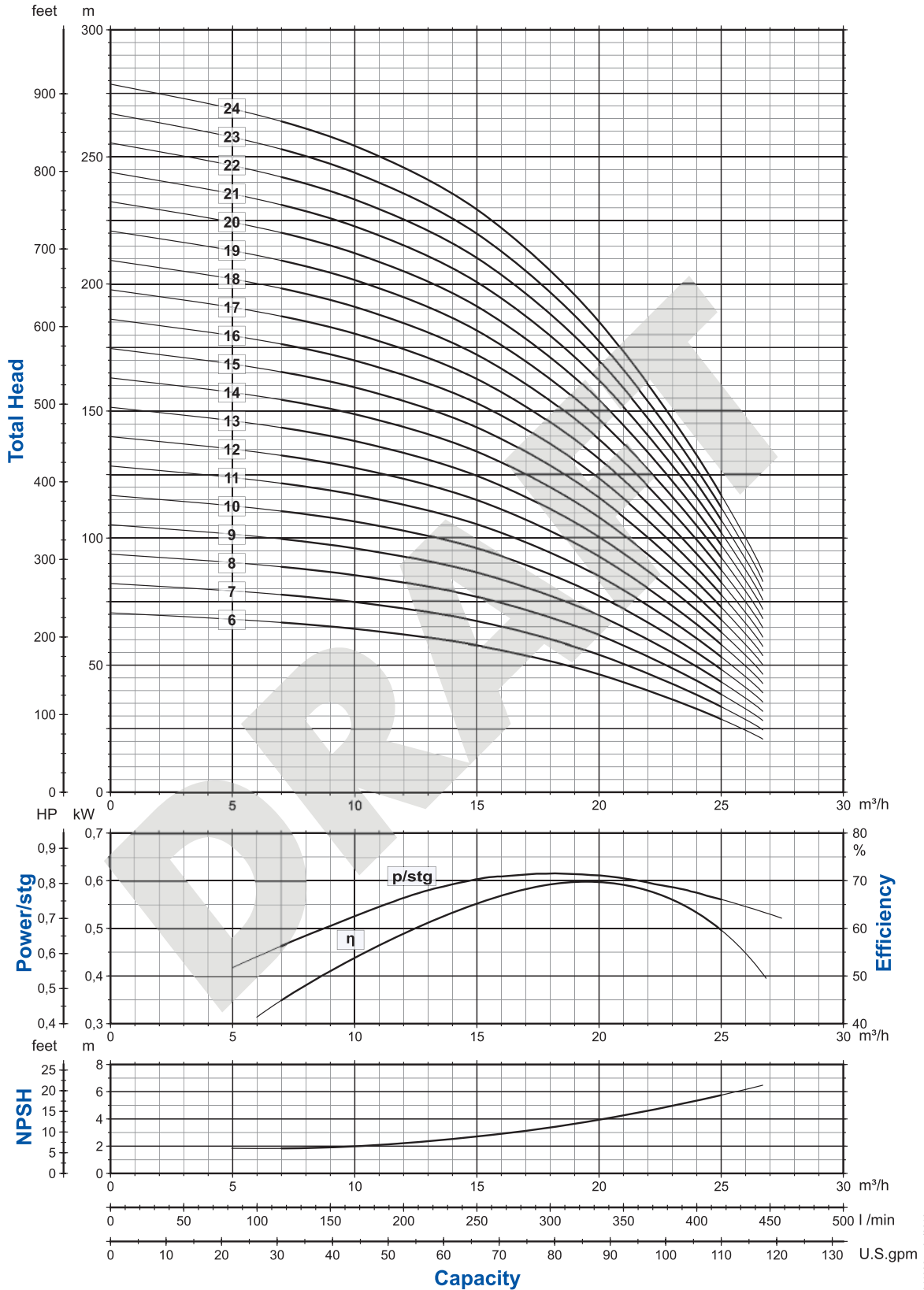

00110067 07/2010

DIMENSIONAL TABLE

Model	Type	Motor kW	HP	Dimensions [mm]				D		Weight [kg]
				L1	L2	Lt	1 cable	2 cables		
6BHE 20/6	E4	3,7	5	497,5	520	1017,5	142,5	-	31,5	
6BHE 20/7	E4	5,5	7,5	535	652,5	1187,5	142,5	-	40	
6BHE 20/8	E4	5,5	7,5	572,5	652,5	1225	142,5	-	41	
6BHE 20/9	E4	5,5	7,5	610	652,5	1262,5	142,5	-	41,5	
6BHE 20/10	E4	7,5	10	647,5	730,5	1378	142,5	-	46,5	
6BHE 20/11	E4	7,5	10	685	730,5	1415,5	142,5	-	47,5	
6BHE 20/12	E4	7,5	10	722,5	730,5	1453	142,5	-	48	
6BHE 20/6	E6	4	5,5	495	581	1076	143	144,5	50	
6BHE 20/7	E6	5,5	7,5	532,5	614,5	1147	143	144,5	54,5	
6BHE 20/8	E6	5,5	7,5	570	614,5	1184,5	143	144,5	55,5	
6BHE 20/9	E6	5,5	7,5	607,5	614,5	1222	143	144,5	56	
6BHE 20/10	E6	7,5	10	645	646	1291	143	144,5	61	
6BHE 20/11	E6	7,5	10	682,5	646	1328,5	143	144,5	62	
6BHE 20/12	E6	7,5	10	720	646	1366	143	144,5	62,5	
6BHE 20/13	E6	9,3	12,5	757,5	678,5	1436	143	144,5	66	
6BHE 20/14	E6	9,3	12,5	795	678,5	1473,5	143	144,5	67	
6BHE 20/15	E6	9,3	12,5	832,5	678,5	1511	143	144,5	67,5	
6BHE 20/16	E6	11	15	870	711	1581	143	144,5	72	
6BHE 20/17	E6	11	15	907,5	711	1618,5	143	144,5	73	
6BHE 20/18	E6	11	15	945	711	1656	143	144,5	73,5	
6BHE 20/19	E6	15	20	982,5	776	1758,5	143	144,5	80	
6BHE 20/20	E6	15	20	1020	776	1796	143	144,5	80,5	
6BHE 20/21	E6	15	20	1057,5	776	1833,5	143	144,5	81,5	
6BHE 20/22	E6	15	20	1095	776	1871	143	144,5	82,5	
6BHE 20/23	E6	15	20	1132,5	776	1908,5	143	144,5	83	
6BHE 20/24	E6	15	20	1170	776	1946	143	144,5	84	

DIMENSIONS

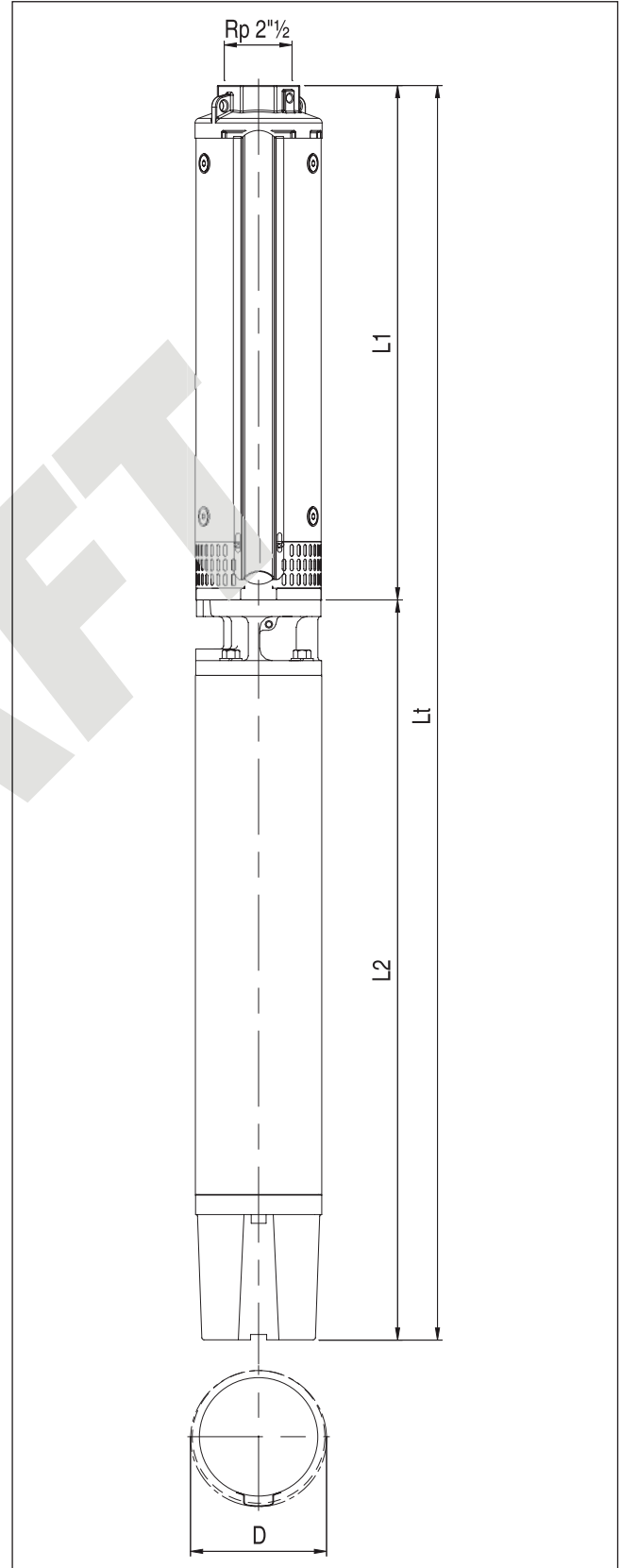



6BHE

6BHE 20 PERFORMANCE CURVES Pumps with Encapsulated Motor

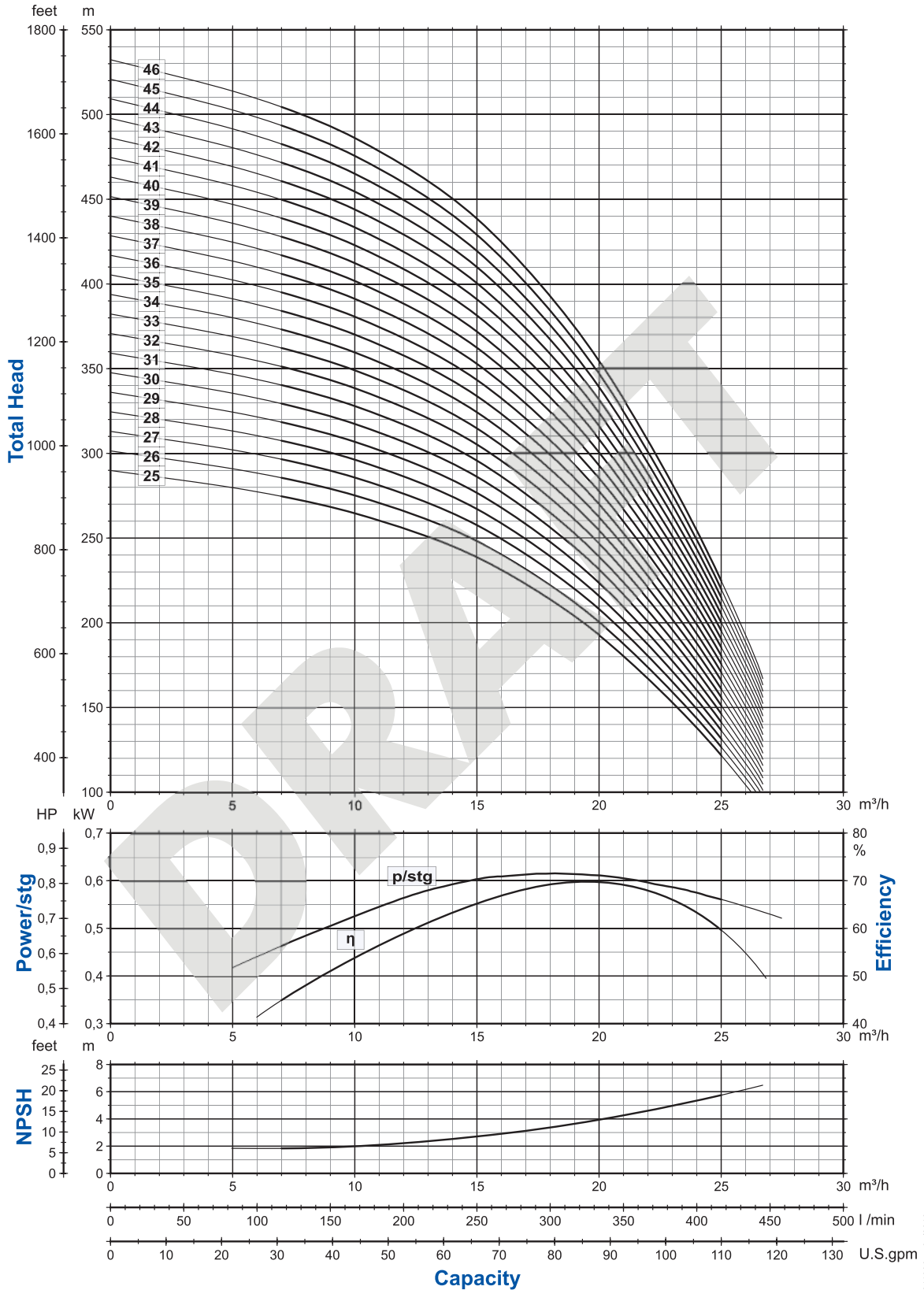

00110067 07/2010

DIMENSIONAL TABLE

Model	Type	Motor kW	HP	Dimensions [mm]					Weight [kg]	
				L1	L2	Lt	D		1 cable	2 cables
6BHE 20/25	E6	18,5	25	1207,5	841,5	2049	143	144,5		
6BHE 20/26	E6	18,5	25	1245	841,5	2086,5	143	144,5	92,5	
6BHE 20/27	E6	18,5	25	1282,5	841,5	2124	143	144,5	94,5	
6BHE 20/28	E6	18,5	25	1319,5	841,5	2161	143	144,5	94,5	
6BHE 20/29	E6	18,5	25	1357	841,5	2198,5	143	144,5	95	
6BHE 20/30	E6	18,5	25	1394,5	841,5	2236	143	144,5	96	
6BHE 20/31	E6	22	30	1432	906,5	2338,5	143	144,5	103	
6BHE 20/32	E6	22	30	1469,5	906,5	2376	143	144,5	103,5	
6BHE 20/33	E6	22	30	1507	906,5	2413,5	143	144,5	104,5	
6BHE 20/34	E6	22	30	1544,5	906,5	2451	143	144,5	105	
6BHE 20/35	E6	22	30	1582	906,5	2488,5	143	144,5	106	
6BHE 20/36	E6	22	30	1619,5	906,5	2526	143	144,5	106,5	
6BHE 20/37	E6	30	40	1657	1036,5	2693,5	143	144,5	122,5	
6BHE 20/38	E6	30	40	1694,5	1036,5	2731	143	144,5	124	
6BHE 20/39	E6	30	40	1732	1036,5	2768,5	143	144,5	124	
6BHE 20/40	E6	30	40	1769,5	1036,5	2806	143	144,5	124,5	
6BHE 20/41	E6	30	40	1807	1036,5	2843,5	143	144,5	126	
6BHE 20/42	E6	30	40	1844,5	1036,5	2881	143	144,5	127	
6BHE 20/43	E6	30	40	1882	1036,5	2918,5	143	144,5	128	
6BHE 20/44	E6	30	40	1919,5	1036,5	2956	143	144,5	129	
6BHE 20/45	E6	30	40	1957	1036,5	2993,5	143	144,5	130	
6BHE 20/46	E6	30	40	1994	1036,5	3030,5	143	144,5	131	

DIMENSIONS

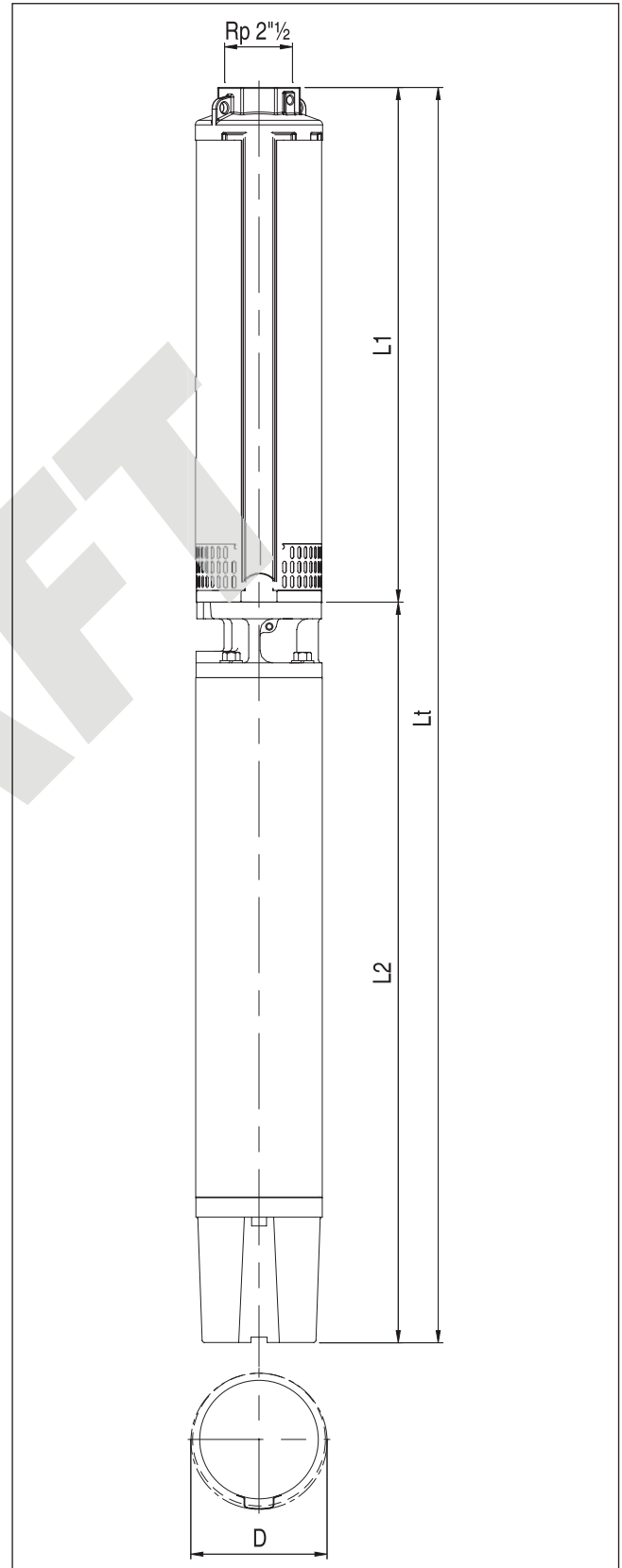

6BHE 20 PERFORMANCE CURVES Pumps with Encapsulated Motor

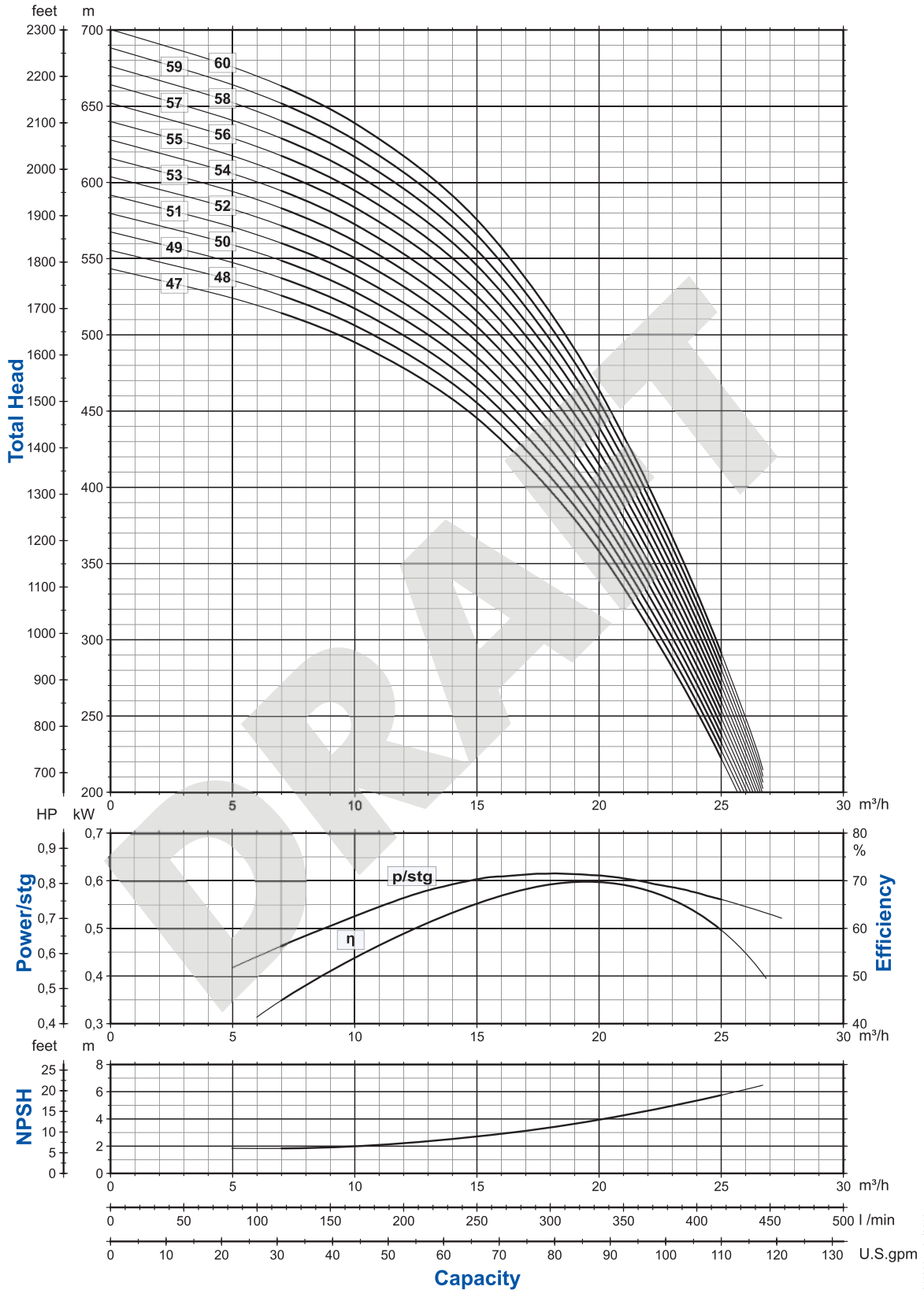

00110067 07/2010

DIMENSIONAL TABLE

Model	Type	Motor kW	HP	Dimensions [mm]					Weight [kg]	
				L1	L2	Lt	D		1 cable	2 cables
6BHE 20/47	E6	30	40	2031,5	1036,5	3068	145	146,5		
6BHE 20/48	E6	30	40	2069	1036,5	3105,5	145	146,5	132	
6BHE 20/49	E6	30	40	2106,5	1036,5	3143	145	146,5	134	
6BHE 20/50	E6	37	50	2144	1421,5	3565,5	145	146,5	189	
6BHE 20/51	E6	37	50	2181,5	1421,5	3603	145	146,5	190	
6BHE 20/52	E6	37	50	2219	1421,5	3640,5	145	146,5	191	
6BHE 20/53	E6	37	50	2256,5	1421,5	3678	145	146,5	192	
6BHE 20/54	E6	37	50	2294	1421,5	3715,5	145	146,5	193	
6BHE 20/55	E6	37	50	2331,5	1421,5	3753	145	146,5	194	
6BHE 20/56	E6	37	50	2369	1421,5	3790,5	145	146,5	195	
6BHE 20/57	E6	37	50	2406,5	1421,5	3828	145	146,5	196	
6BHE 20/58	E6	37	50	2444	1421,5	3865,5	145	146,5	197	
6BHE 20/59	E6	37	50	2481,5	1421,5	3903	145	146,5	198	
6BHE 20/60	E6	37	50	2519	1421,5	3940,5	145	146,5	199	

DIMENSIONS

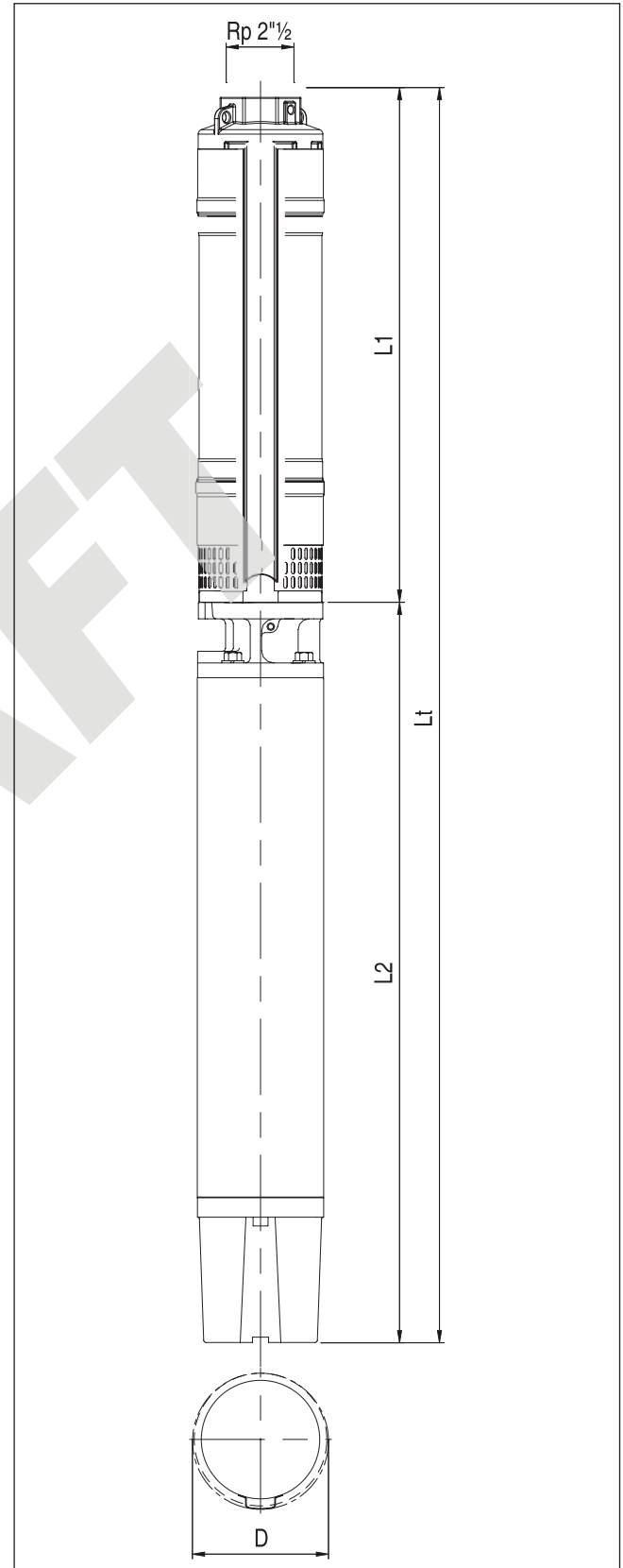

6BHE 32 PERFORMANCE CURVES Pumps with Encapsulated Motor

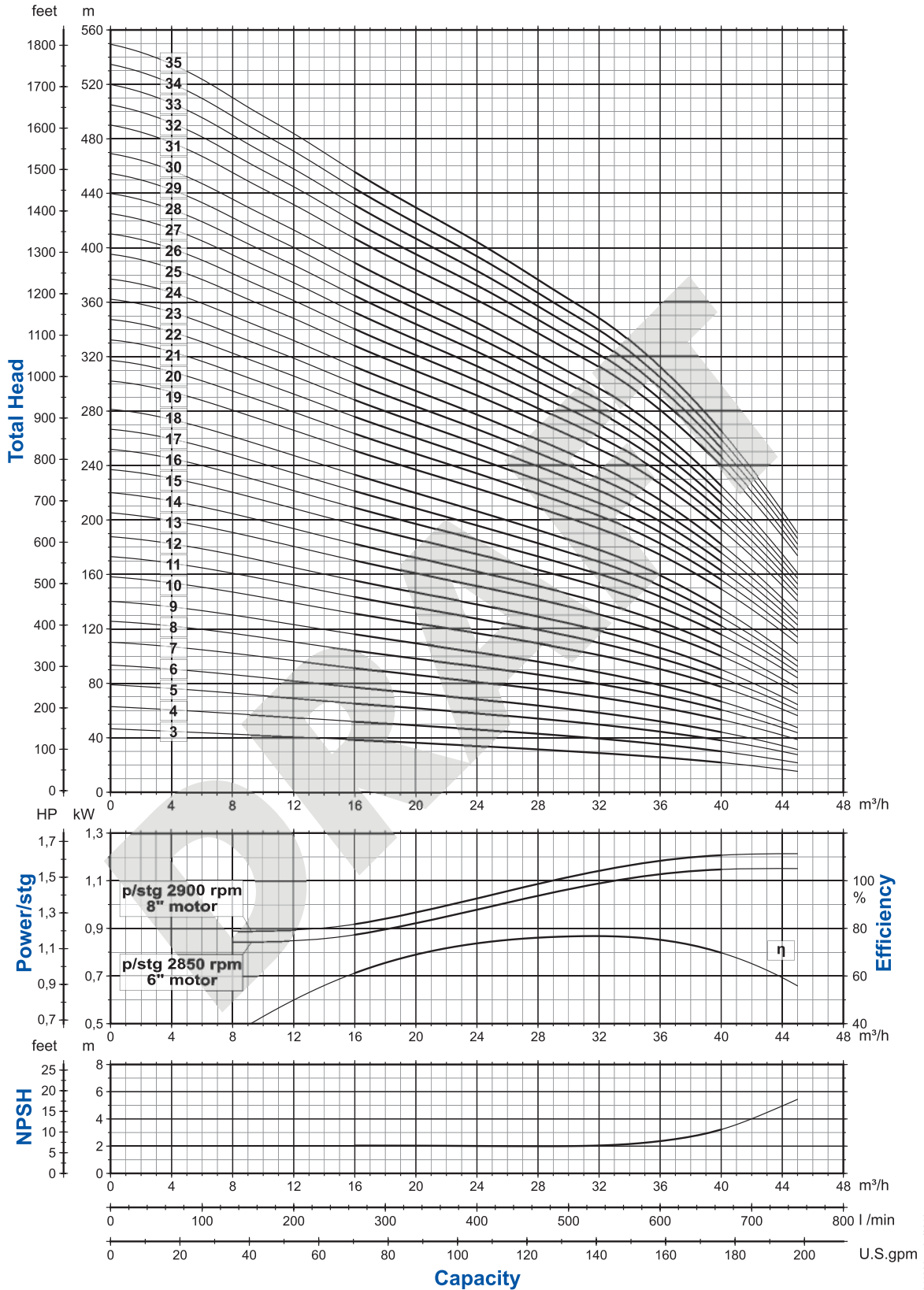

DIMENSIONAL TABLE

Model	Type	Motor kW	HP	Dimensions [mm]				D		Weight [kg]
				L1	L2	Lt	1 cable	2 cables		
6BHE 32/3	E4	3,7	5	622	520	1142	142,5	-	34	
6BHE 32/4	E4	5,5	7,5	707,5	652,5	1360	142,5	-	43,5	
6BHE 32/5	E4	7,5	10	793	730,5	1523,5	142,5	-	50	
6BHE 32/6	E4	7,5	10	878,5	730,5	1609	142,5	-	52	
6BHE 32/3	E6	4	5,5	620	581	1201	143	144,5	52	
6BHE 32/4	E6	5,5	7,5	705,5	614,5	1320	143	144,5	58	
6BHE 32/5	E6	7,5	10	790,5	646	1436,5	143	144,5	64	
6BHE 32/6	E6	7,5	10	876	646	1522	143	144,5	66	
6BHE 32/7	E6	9,3	12,5	961,5	678,5	1640	143	144,5	70,5	
6BHE 32/8	E6	11	15	1047	711	1758	143	144,5	76,5	
6BHE 32/9	E6	11	15	1132,5	711	1843,5	143	144,5	78,5	
6BHE 32/10	E6	15	20	1218	776	1994	143	144,5	86	
6BHE 32/11	E6	15	20	1303,5	776	2079,5	143	144,5	88	
6BHE 32/12	E6	15	20	1389	776	2165	143	144,5	90	
6BHE 32/13	E6	18,5	25	1474,5	841,5	2316	143	144,5	99	
6BHE 32/14	E6	18,5	25	1560	841,5	2401,5	143	144,5	101,5	
6BHE 32/15	E6	22	30	1645,5	906,5	2552	143	144,5	109,5	
6BHE 32/16	E6	22	30	1730,5	906,5	2637	143	144,5	111,5	
6BHE 32/17	E6	22	30	1816	906,5	2722,5	143	144,5	113,5	
6BHE 32/18	E6	22	30	1901,5	906,5	2808	143	144,5	115,5	
6BHE 32/19	E6	30	40	1987	1036,5	3023,5	143	144,5	132	
6BHE 32/20	E6	30	40	2072,5	1036,5	3109	143	144,5	134,5	
6BHE 32/21	E6	30	40	2157,5	1036,5	3194	143	144,5	136,5	
6BHE 32/22	E6	30	40	2243	1036,5	3279,5	143	144,5	138,5	
6BHE 32/23	E6	30	40	2328,5	1036,5	3365	143	144,5	140,5	
6BHE 32/24	E6	30	40	2414	1036,5	3450,5	143	144,5	142,5	
6BHE 32/25	E6	37	50	2499	1421,5	3920,5	143	144,5	199	
6BHE 32/26	E6	37	50	2584,5	1421,5	4006	143	144,5	201	
6BHE 32/27	E6	37	50	2670	1421,5	4091,5	143	144,5	203	
6BHE 32/28	E6	37	50	2755	1421,5	4176,5	143	144,5	205	
6BHE 32/29	E6	37	50	2840,5	1421,5	4262	143	144,5	207	
6BHE 32/30	E6	37	50	2926	1421,5	4347,5	143	144,5	209,5	
6BHE 32/31	E6	45	60	3011	1574	4585	143	144,5	224,5	
6BHE 32/32	E6	45	60	3096,5	1574	4670,5	143	144,5	227,5	
6BHE 32/33	E6	45	60	3182	1574	4756	143	144,5	229,5	
6BHE 32/34	E6	45	60	3267,5	1574	4841,5	143	144,5	231,5	
6BHE 32/35	E6	45	60	3352,5	1574	4926,5	143	144,5	234	

DIMENSIONS

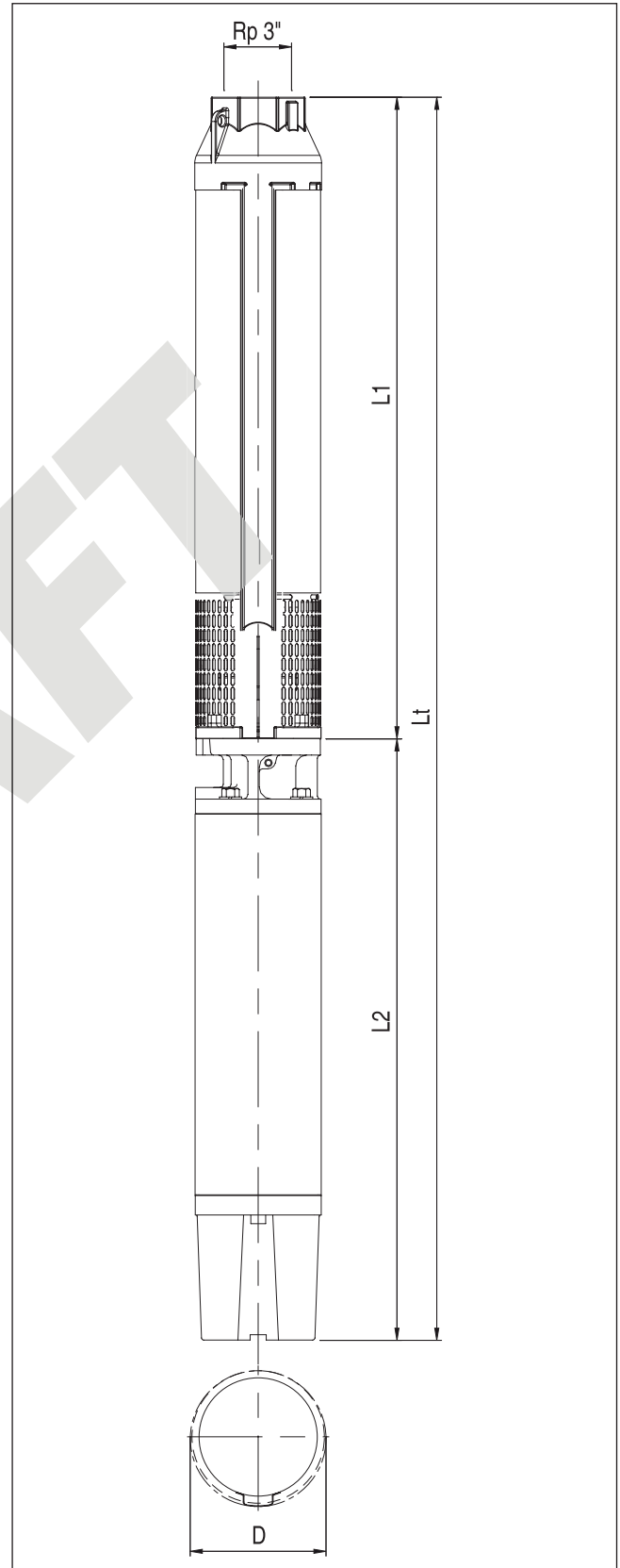

6BHE 32 PERFORMANCE CURVES Pumps with Encapsulated Motor

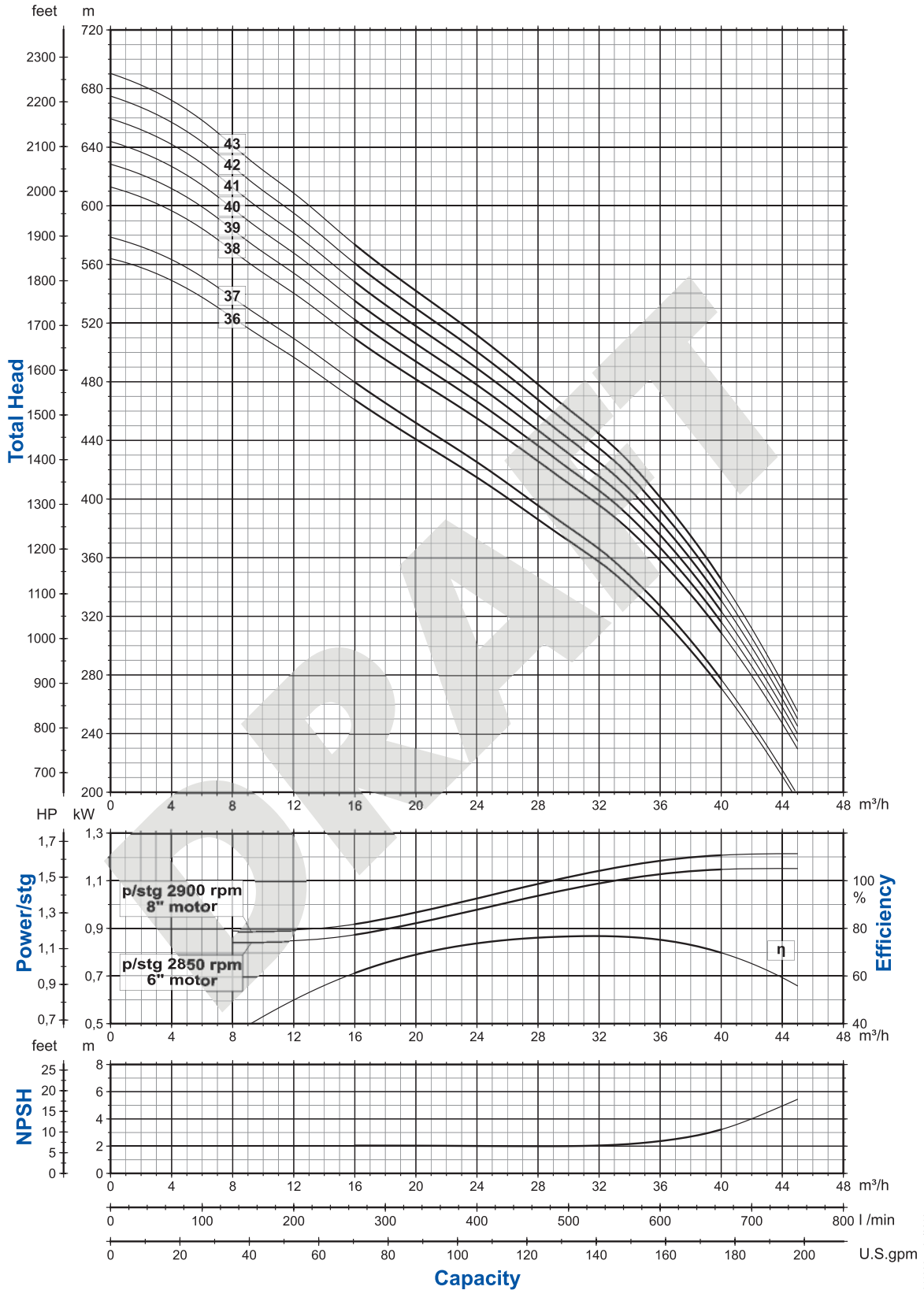

00110067 07/2010

DIMENSIONAL TABLE

Model	Type	Motor kW	HP	Dimensions [mm]			D		Weight [kg]
				L1	L2	Lt	1 cable	2 cables	
6BHE 32/36	E6	45	60	3438	1574	5012	145	146,5	237
6BHE 32/37	E6	45	60	3523,5	1574	5097,5	145	146,5	239
6BHE 32/38	E8	55	75	3709	1204	4913	190,5	190,5	270,5
6BHE 32/39	E8	55	75	3794	1204	4998	190,5	190,5	272,5
6BHE 32/40	E8	55	75	3879,5	1204	5083,5	190,5	190,5	275
6BHE 32/41	E8	55	75	3965	1204	5169	190,5	190,5	276
6BHE 32/42	E8	55	75	4050,5	1204	5254,5	190,5	190,5	277
6BHE 32/43	E8	55	75	4135,5	1204	5339,5	190,5	190,5	278

DIMENSIONS

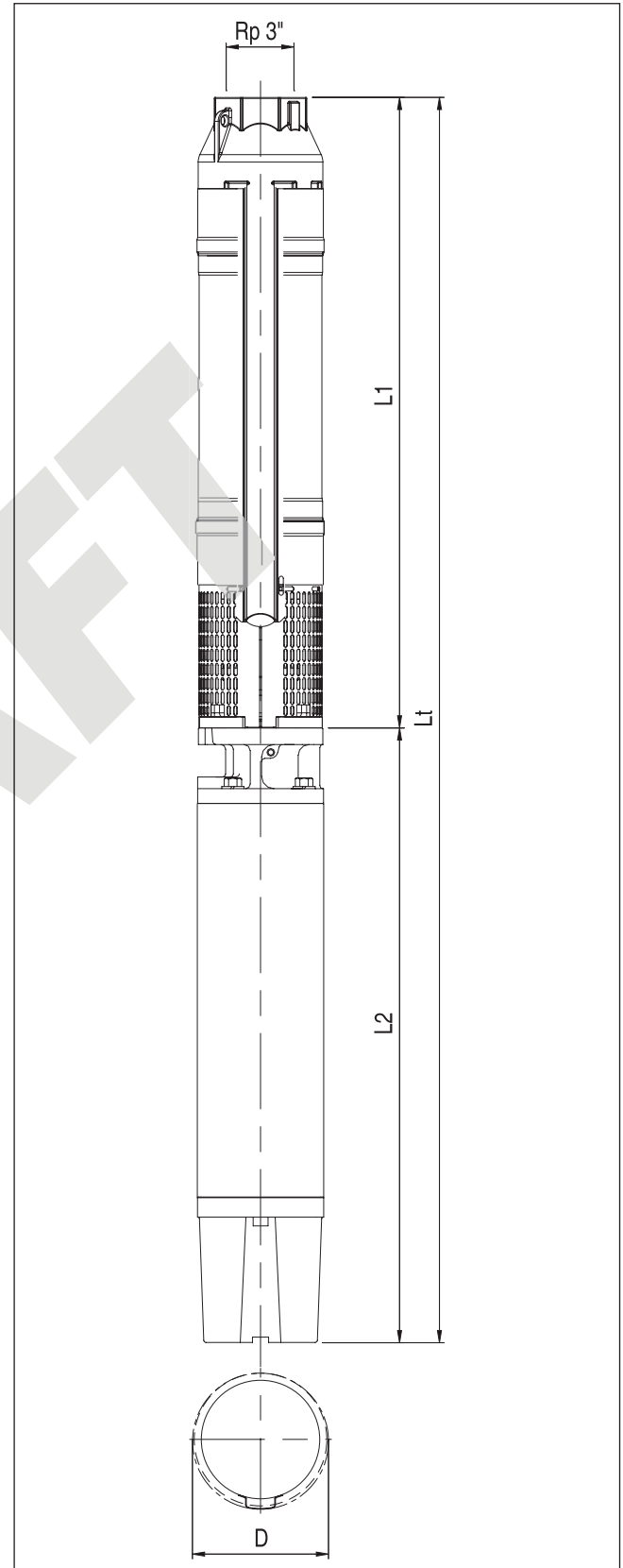

6BHE 48 PERFORMANCE CURVES Pumps with Encapsulated Motor

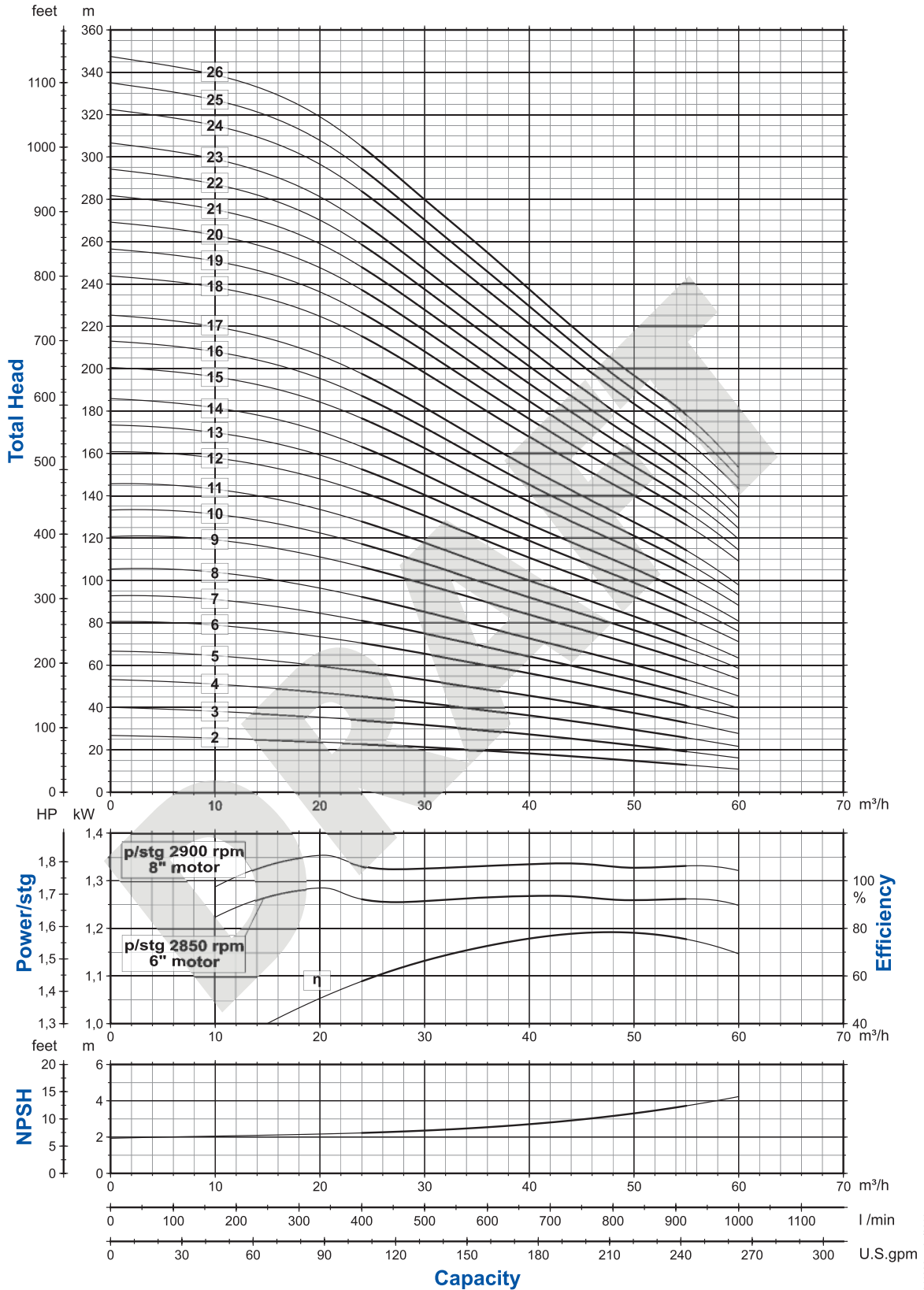

00110067 07/2010

DIMENSIONAL TABLE

Model	Type	Motor kW	HP	Dimensions [mm]				D		Weight [kg]
				L1	L2	Lt	1 cable	2 cables		
6BHE 48/2	E4	3	4	593,5	477	1070,5	142,5	-	31	
6BHE 48/3	E4	4	5,5	707,5	543	1250,5	142,5	-	36,5	
6BHE 48/4	E4	5,5	7,5	821,5	652,5	1474	142,5	-	45,5	
6BHE 48/5	E4	7,5	10	935,5	730,5	1666	142,5	-	52,5	
6BHE 48/2	E6	4	5,5	591,5	581	1172,5	143	144,5	51	
6BHE 48/3	E6	4	5,5	705,5	581	1286,5	143	144,5	53,5	
6BHE 48/4	E6	5,5	7,5	819,5	614,5	1434	143	144,5	60	
6BHE 48/5	E6	7,5	10	933,5	646	1579,5	143	144,5	66,5	
6BHE 48/6	E6	9,3	12,5	1047	678,5	1725,5	143	144,5	71,5	
6BHE 48/7	E6	9,3	12,5	1161	678,5	1839,5	143	144,5	74	
6BHE 48/8	E6	11	15	1275	711	1986	143	144,5	80	
6BHE 48/9	E6	15	20	1389	776	2165	143	144,5	88,5	
6BHE 48/10	E6	15	20	1503	776	2279	143	144,5	91	
6BHE 48/11	E6	15	20	1617	776	2393	143	144,5	93,5	
6BHE 48/12	E6	18,5	25	1730,5	841,5	2572	143	144,5	103	
6BHE 48/13	E6	18,5	25	1844,5	841,5	2686	143	144,5	105,5	
6BHE 48/14	E6	18,5	25	1958,5	841,5	2800	143	144,5	108,5	
6BHE 48/15	E6	22	30	2072,5	906,5	2979	143	144,5	117	
6BHE 48/16	E6	22	30	2186	906,5	3092,5	143	144,5	119,5	
6BHE 48/17	E6	22	30	2300	906,5	3206,5	143	144,5	122	
6BHE 48/18	E6	30	40	2414	1036,5	3450,5	143	144,5	139,5	
6BHE 48/19	E6	30	40	2527,5	1036,5	3564	143	144,5	142	
6BHE 48/20	E6	30	40	2641,5	1036,5	3678	143	144,5	144,5	
6BHE 48/21	E6	30	40	2755	1036,5	3791,5	143	144,5	147	
6BHE 48/22	E6	30	40	2869	1036,5	3905,5	143	144,5	149,5	
6BHE 48/23	E6	30	40	2983	1036,5	4019,5	143	144,5	152,5	
6BHE 48/24	E6	37	50	3096,5	1421,5	4518	143	144,5	209	
6BHE 48/25	E6	37	50	3210,5	1421,5	4632	143	144,5	211,5	
6BHE 48/26	E6	37	50	3324	1421,5	4745,5	143	144,5	214	

DIMENSIONS

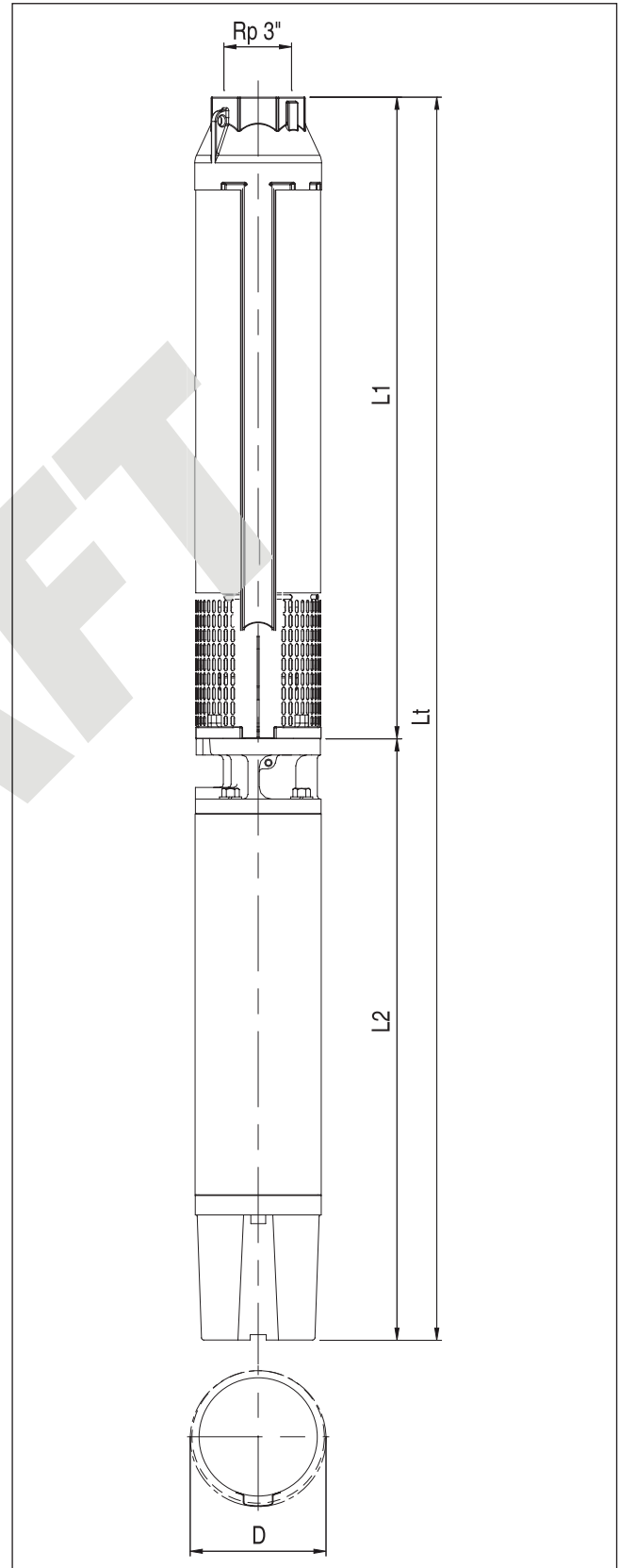

6BHE 48 PERFORMANCE CURVES Pumps with Encapsulated Motor

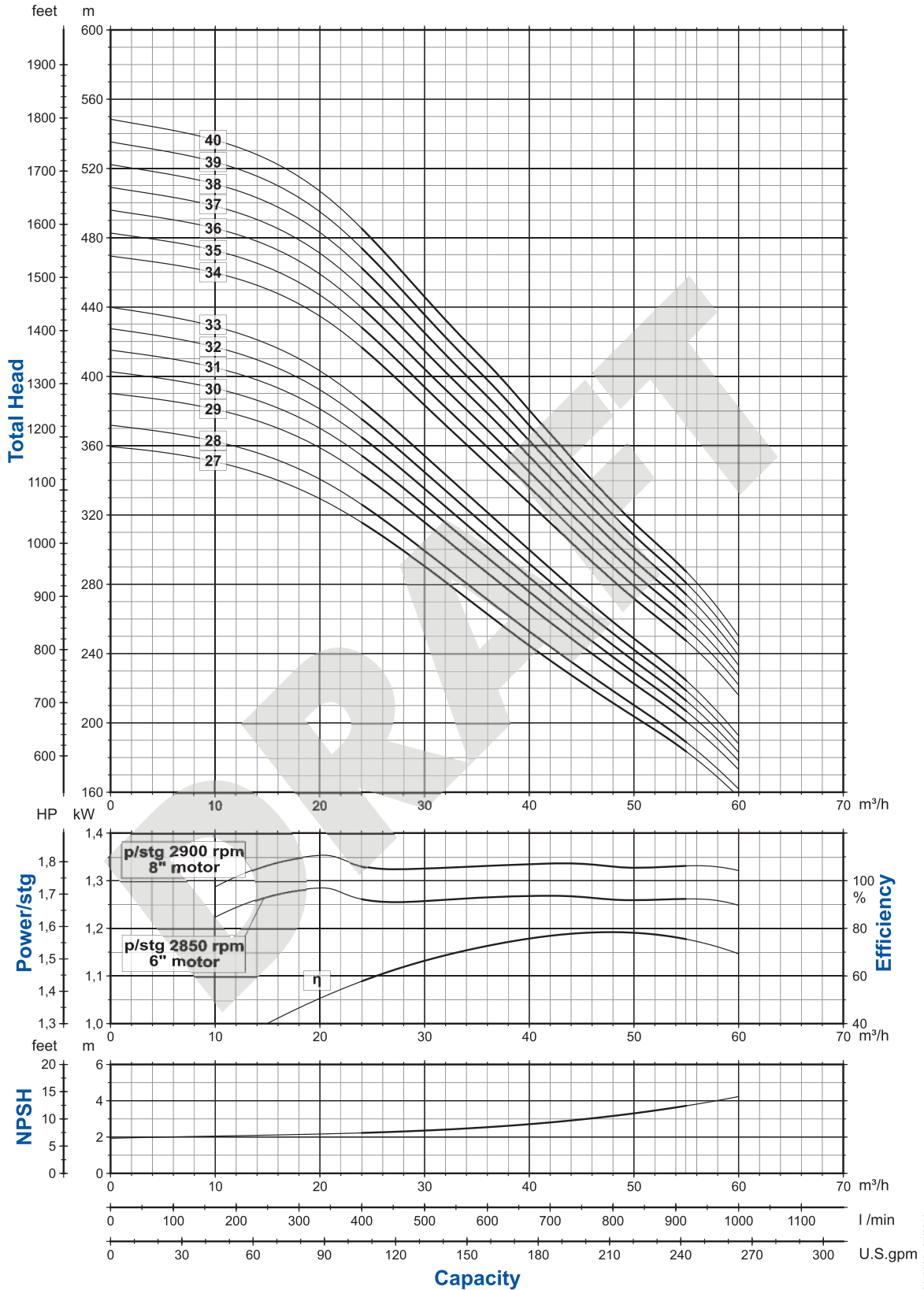

00110067 07/2010

DIMENSIONAL TABLE

Model	Type	Motor kW	HP	L1	Dimensions [mm]			D		Weight [kg]
					L2	Lt	1 cable	2 cables		
6BHE 48/27	E6	37	50	3438	1421,5	4859,5	145	146,5	217,5	
6BHE 48/28	E6	37	50	3552	1421,5	4973,5	145	146,5	220	
6BHE 48/29	E6	45	60	3665,5	1574	5239,5	145	146,5	236,5	
6BHE 48/30	E6	45	60	3779,5	1574	5353,5	145	146,5	239	
6BHE 48/31	E6	45	60	3893,5	1574	5467,5	145	146,5	242	
6BHE 48/32	E6	45	60	4007	1574	5581	145	146,5	244,5	
6BHE 48/33	E6	45	60	4121	1574	5695	145	146,5	247	
6BHE 48/34	E8	55	75	4335	1204	5539	190,5	190,5	279	
6BHE 48/35	E8	55	75	4449	1204	5653	190,5	190,5	281,5	
6BHE 48/36	E8	55	75	4562,5	1204	5766,5	190,5	190,5	284,5	
6BHE 48/37	E8	55	75	4676,5	1204	5880,5	190,5	190,5	287	
6BHE 48/38	E8	55	75	4790,5	1204	5994,5	190,5	190,5	289,5	
6BHE 48/39	E8	55	75	4904,5	1204	6108,5	190,5	190,5	292	
6BHE 48/40	E8	55	75	5018,5	1204	6222,5	190,5	190,5	295	

DIMENSIONS

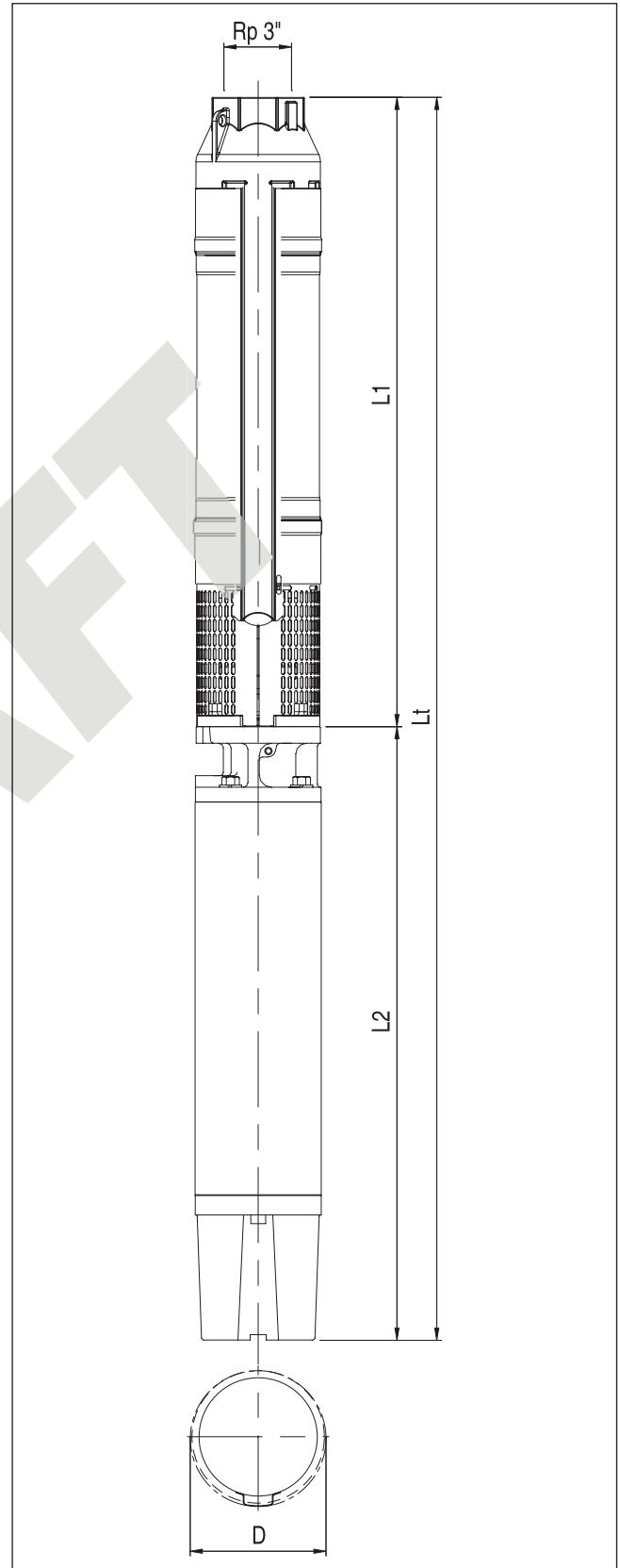

6BHE 64 PERFORMANCE CURVES Pumps with Encapsulated Motor

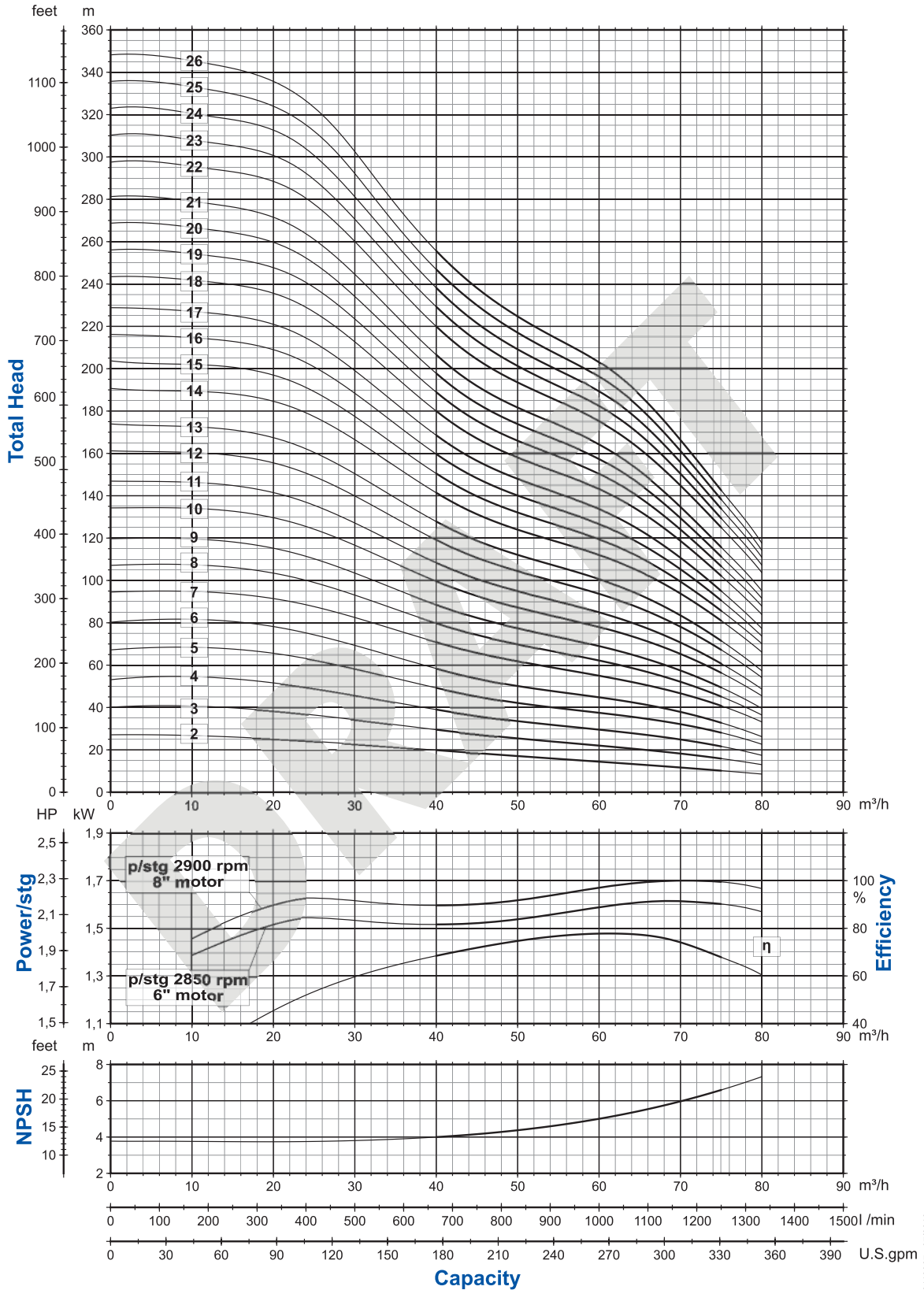

00110067 07/2010

DIMENSIONAL TABLE

Model	Type	Motor kW	HP	Dimensions [mm]				D		Weight [kg]
				L1	L2	Lt	1 cable	2 cables		
6BHE 64/2	E4	3,7	5	593,5	520	1113,5	142,5	-	33	
6BHE 64/3	E4	5,5	7,5	707,5	652,5	1360	142,5	-	43	
6BHE 64/4	E4	7,5	10	821,5	730,5	1552	142,5	-	49,5	
6BHE 64/2	E6	4	5,5	591,5	581	1172,5	143	144,5	51	
6BHE 64/3	E6	5,5	7,5	705,5	614,5	1320	143	144,5	57	
6BHE 64/4	E6	7,5	10	819,5	646	1465,5	143	144,5	64	
6BHE 64/5	E6	9,3	12,5	933,5	678,5	1612	143	144,5	69	
6BHE 64/6	E6	11	15	1047	711	1758	143	144,5	75	
6BHE 64/7	E6	15	20	1161	776	1937	143	144,5	83	
6BHE 64/8	E6	15	20	1275	776	2051	143	144,5	86	
6BHE 64/9	E6	15	20	1389	776	2165	143	144,5	88,5	
6BHE 64/10	E6	18,5	25	1503	841,5	2344,5	143	144,5	98	
6BHE 64/11	E6	18,5	25	1617	841,5	2458,5	143	144,5	100,5	
6BHE 64/12	E6	22	30	1730,5	906,5	2637	143	144,5	109	
6BHE 64/13	E6	22	30	1844,5	906,5	2751	143	144,5	112	
6BHE 64/14	E6	30	40	1958,5	1036,5	2995	143	144,5	129	
6BHE 64/15	E6	30	40	2072,5	1036,5	3109	143	144,5	131,5	
6BHE 64/16	E6	30	40	2186	1036,5	3222,5	143	144,5	134	
6BHE 64/17	E6	30	40	2300	1036,5	3336,5	143	144,5	137	
6BHE 64/18	E6	37	50	2414	1421,5	3835,5	143	144,5	193,5	
6BHE 64/19	E6	37	50	2527,5	1421,5	3949	143	144,5	196	
6BHE 64/20	E6	37	50	2641,5	1421,5	4063	143	144,5	198,5	
6BHE 64/21	E6	37	50	2755	1421,5	4176,5	143	144,5	201,5	
6BHE 64/22	E6	45	60	2869	1574	4443	143	144,5	218	
6BHE 64/23	E6	45	60	2983	1574	4557	143	144,5	220,5	
6BHE 64/24	E6	45	60	3096,5	1574	4670,5	143	144,5	223	
6BHE 64/25	E6	45	60	3210,5	1574	4784,5	143	144,5	225,5	
6BHE 64/26	E6	45	60	3324	1574	4898	143	144,5	228,5	

DIMENSIONS

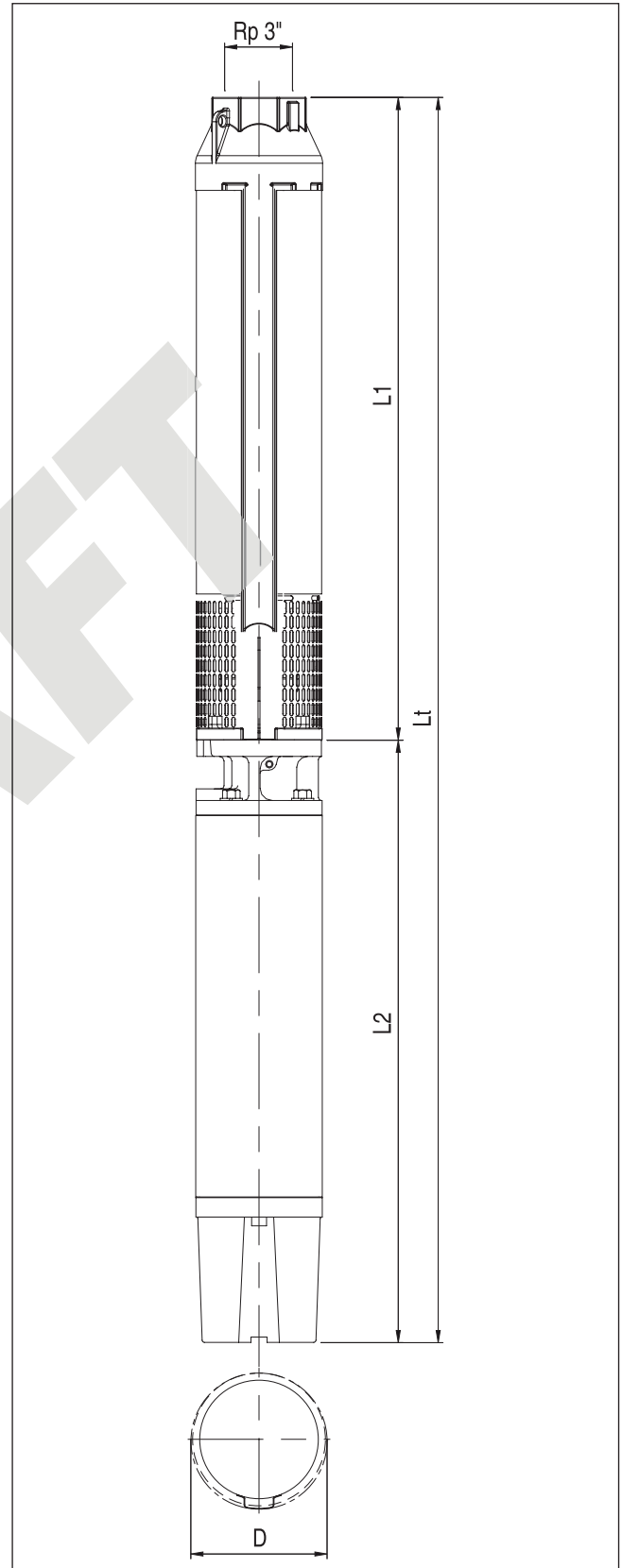



6BHE

6BHE 64 PERFORMANCE CURVES Pumps with Encapsulated Motor

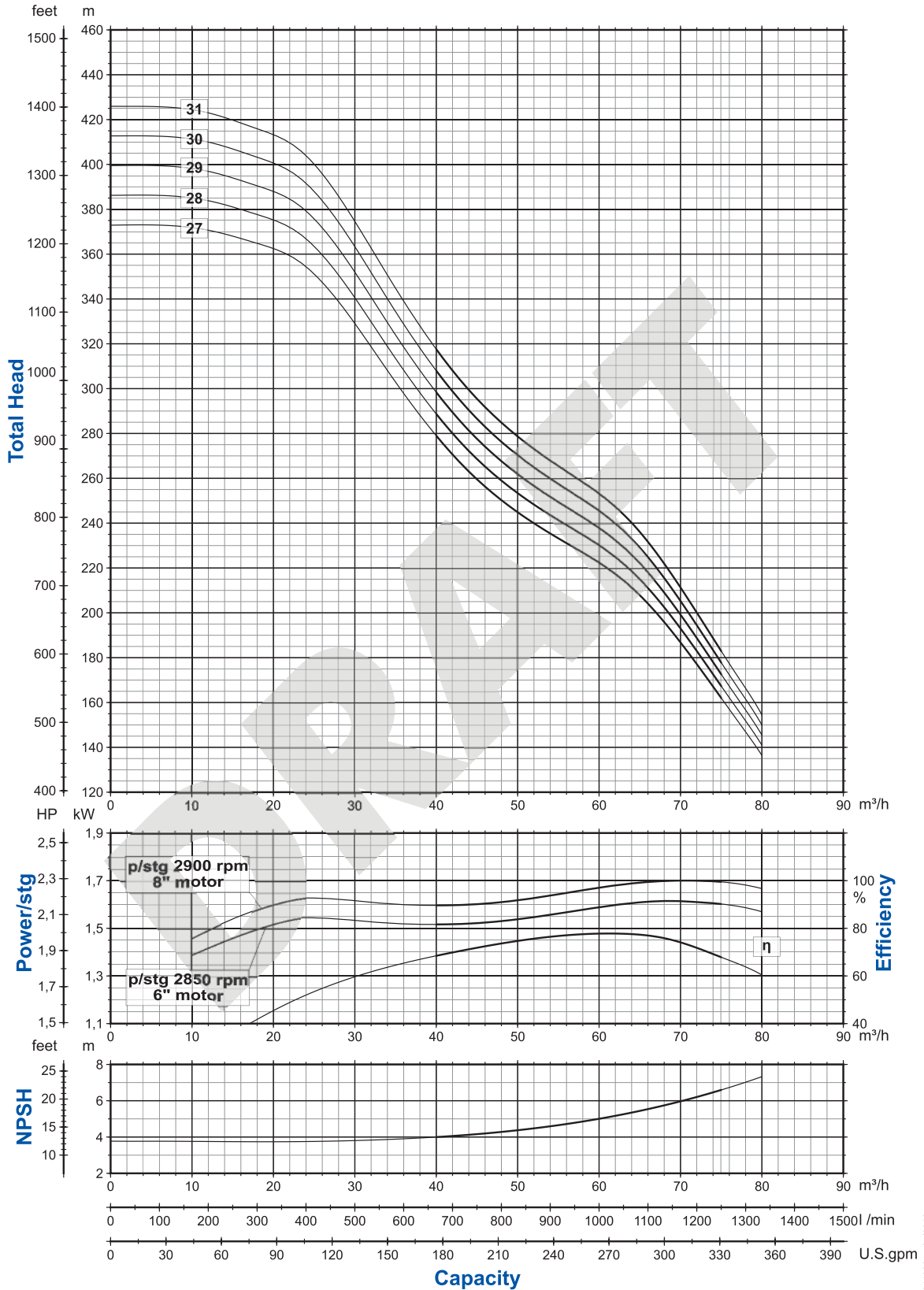

00110067 07/2010

DIMENSIONAL TABLE

Model	Type	Motor kW	HP	L1	Dimensions [mm]			D		Weight [kg]
					L2	Lt	1 cable	2 cables		
6BHE 64/27	E8	55	75	3538	1204	4742	190,5	190,5	261	
6BHE 64/28	E8	55	75	3652	1204	4856	190,5	190,5	263,5	
6BHE 64/29	E8	55	75	3765,5	1204	4969,5	190,5	190,5	266	
6BHE 64/30	E8	55	75	3879,5	1204	5083,5	190,5	190,5	268,5	
6BHE 64/31	E8	55	75	3993,5	1204	5197,5	190,5	190,5	271,5	

DIMENSIONS

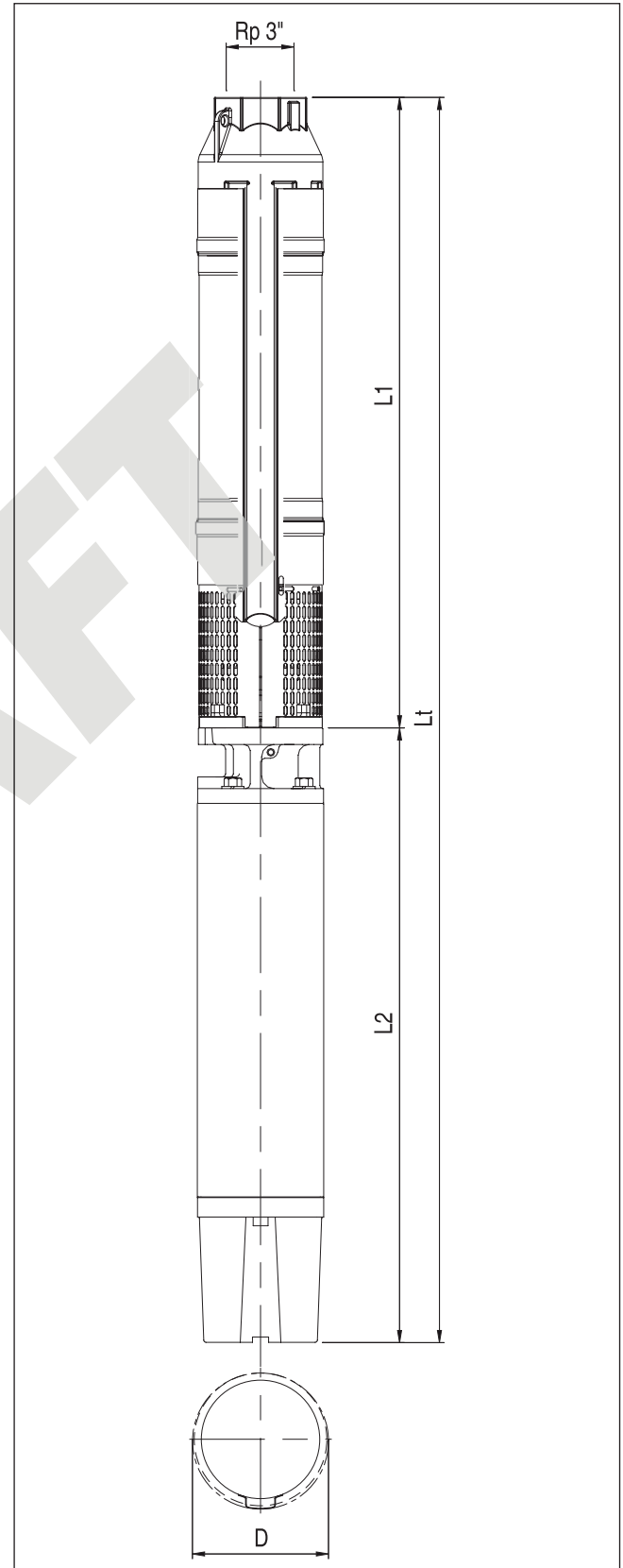

EBARA Pumps Europe network

HEAD OFFICE

EBARA Pumps Europe S.p.A.

Via Pacinotti, 32
36040 Brendola (VI), Italy
Phone +39 0444 706811 - Fax +39 0444 405811
Italian orders:
ordini@ebaraeurope.com
Export orders:
exportsales@ebaraeurope.com
Technical Customer Service (TCS):
technical_customer_service@ebaraeurope.com
Phone +39 0444 706902/923

ITALIAN SALES DEPARTMENTS

EBARA MILANO

Via Lainate, 62
20017 Rho (MI)
Phone 02 93507358 - Fax 0444 405975

EBARA ROMA

Via Guido Rossa, 34
Scala B - Piano 2 - interno 11
00065 Fiano Romano (RM)
Fax 0444 405990

EBARA CAGLIARI

Via del Fangario, 29
09122 Cagliari
Phone 070 274281 - Fax 0444 405960

EBARA PALERMO

Via Don L. Sturzo, 181/183
Z.I. - 90044 Carini (PA)
Phone 091 8669790 - Fax 0444 405980

EXPORT NETWORK

EBARA Pumps Europe S.p.A. UNITED KINGDOM

Unit 7 - Zodiac Business Park
High Road - Cowley Uxbridge
Middlesex - UB8 2GU, United Kingdom
Phone +44 1895 439027
Fax +44 1895 439028

EBARA ESPAÑA BOMBAS S.A.

C/Cormoranes 6 Y 8
Poligono Ind. La Estación
28320 Pinto (Madrid), Spain
Phone +34 916.923.630
Fax +34 916.910.818

EBARA Pumps Europe S.p.A. FRANCE

555, Rue Juliette Recamier
69970 Chaponnay, France
Phone +33 4 72769482
Fax +33 805101071

EBARA Pumps Europe S.p.A. GERMANY

Ferdinand-Porsche-Ring 7
63110 Rodgau-Jügesheim, Germany
Phone +49 (0) 6106-660 99-0
Fax +49 (0) 6106-660 99-45

EBARA POMPY POLSKA Sp. z o.o.

ul. Działkowa 115
02-234 Warszawa, Poland
Phone +48 22 3909920
Fax +48 22 3909929

EBARA Pumps Europe S.p.A. MIDDLE EAST

P.O. Box 54515
Dubai Airport Free Zone
Dubai, United Arab Emirates
Phone +971 4 609 1040
Fax +971 4 609 1038

EBARA Pumps Europe S.p.A INDIA LIAISON OFFICE

Bhumiraj Costarica,
Room No. 1503, Sector -18,
Palm Beach Rd., Sanpada,
Navi Mumbai, Maharashtra, India
Phone +91 22 27812862/63/64
Fax +91 22 27812865

EBARA Pumps Europe S.p.A. RUSSIA

Phone +7 985 7672672



EBARA Pumps Europe S.p.A.

Via Pacinotti, 32
36040 Brendola (Vicenza), Italy
Phone +39 0444 706811 - Fax +39 0444 405811
Plants: Cles, Brendola
e-mail: marketing@ebaraeurope.com
www.ebaraeurope.com



EBARA Corporation

11-1, Haneda Asahi-cho, Ohta-ku,
Tokyo 144-8510
Japan
Phone +81 3 6275 7598 - Fax +81 3 5736 3193
www.ebara.com